



2024/25 Collection



Cool Breeze Warm Air Re-Circulation Low Running Costs Contemporary Style

High quality ceiling fans to help you relax, sleep well, cool down, warm up, feel good, beat jet lag, impress your friends, save energy and improve your life!



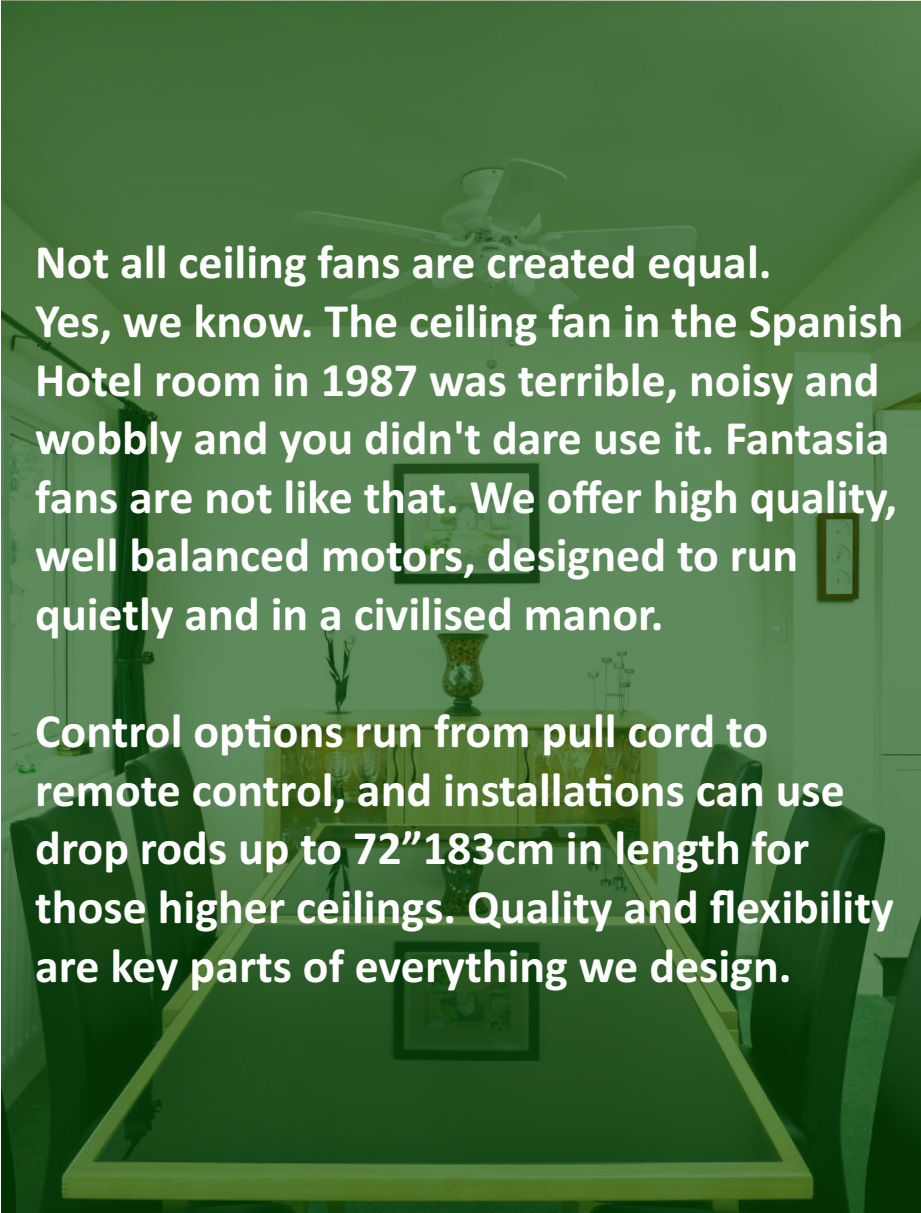

Not all ceiling fans are created equal. Yes, we know. The ceiling fan in the Spanish Hotel room in 1987 was terrible, noisy and wobbly and you didn't dare use it. Fantasia fans are not like that. We offer high quality, well balanced motors, designed to run quietly and in a civilised manor.

Control options run from pull cord to remote control, and installations can use drop rods up to 72"183cm in length for those higher ceilings. Quality and flexibility are key parts of everything we design.

Why you will benefit from a ceiling fan

A ceiling fan will change your life for the better. That's right, you read that correctly. People who have ceiling fans always tell us they couldn't do without one (or 6). People who've bought one often buy another and another.

The feedback from customers is very often "I don't know how I managed without a ceiling fan. Ceiling fans can be the difference between a good night's sleep and a bad night's sleep, they can make a room usable rather than far too hot, they can also even out the temperature in a room so that you radiators or heat pump (!) actually work efficiently and your thermostat actually knows what temperature the room is.

What are these things worth to you?

The Questions we are asked most regularly:

Are Ceiling Fans Noisy?

Everyone has had an experience of a noisy ceiling fan. At Fantasia, our motors are designed to be as quiet as possible and certainly at the higher end of the range we would expect you to be able to sleep under a fan spinning on medium speed all night.

Can I operate the fan and light independently?

A surprisingly common question, the answer is yes. Complete independent control of fan and light is no problem on any Fantasia ceiling fan

The power consumption question – AC/DC, which is best?

Lets face it, Moneytalks, and it Ain't No Fun spending too much on your energy bill, that last place you want to be is on the Highway to Hell. So is AC or DC the better motor option?

Well all Fantasia ceiling fan motors can be considered low energy as they are all below 100w when operated on high speed. DC motors do run with lower power consumption (usually 30-40w) but the main benefit comes with more features that DC motors bring. More speeds (6 rather than 3), and also pulse functions (speed up, slow down, speed up, slow down etc) mean that DC motors are a better choice for some.

Do I need special wiring for a ceiling fan?

No, all Fantasia ceiling fans are designed to run on the 5amp lighting circuit.

How does the fan attach to the ceiling?

A fixing bracket or plate is included with the fan. It is essential that the ceiling fan is mounted securely to a ceiling joist (not just

So you know you want a ceiling fan, but which one?

What Size?

Unless space is an issue then we recommend a 36" fan be the absolute minimum size you should fit in a room. We do make smaller ones but they are really for areas that cannot fit a larger fan. For a standard bedroom a single 42"-52" fan situated above the bed will work well, for a large rectangular lounge you may want to fit 2 x 42" fans or 1 x 52"-56" fan

What colour/finish?

If you want the fan to blend into the ceiling then got for a Matt White finish. After a week or so you'll hardly notice it. If you want the fan to be a feature in the room then Brushed Nickel is a lovely finish. You'll also find other finishes to suit your own décor.

What's your budget?

How much you want to spend will dictate whether you go for a DC motor rather than an AC motor, or if you have remote control operation rather than pull cord. Very generally larger ceiling fans cost a little more too.

Contents

Elite Range

Sirocco
Aero
Tau
Prima
Zeta
Viper Plus
Blade

Fantasia Range

Darwin
Palm
Gemini
Orion
Classic
Titan
Kompact
Capri
Mayfair

Eurofans Range

Neptune
Breeze
Belaire
Montana & Moreno
Atlanta
Commercial Fans

Contact us

We're small family business and we want to help as much as possible but calling us on the phone (particularly in Summer) will not be the quickest way of getting answers to your questions. The best options are:

1. Check the website knowledge base. Your questions will have been asked before and the answer is there. www.fantasiaceilingfans.com
2. Live chat. Also on our website, we can respond quickly there
3. Whatsapp. Message us on 07599 095556 and again you will get an answer quickly.

117759

White 40"/102cm
Blades: White



Fun Fact: When operated on low speed the Luna ceiling fan motor consumes just 4 watts

Remote
Control
Included



117773

White 46"/117cm
Blades: White



**DC
MOTOR**

Extra Efficiency

MAX
POWER
CONSUMPTION

57w

ON HIGH SPEED WITH
LIGHT SWITCHED ON

MAX
AIRFLOW
**7400 CU/FT
PER MINUTE**

KEY FEATURES AND BENEFITS

- Lovely sleek design
- Complete remote control system offering 6 speeds in forward & reverse and light on/off/dim, and 1hr, 2hr, 4hr timer
- 22w Dimmable LED light
- LED Light with colour changing technology. Can be set at colour temperatures 3000k, 4000k or 6000
- Reversible - Use in Summer for Cooling and in Winter to re-circulate warm air
- Longer drop rods available

Ideal for Bedrooms, Living Rooms, Orangeries and Conservatories

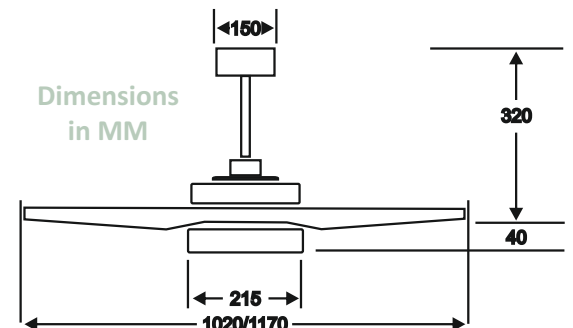

INSTALLATION

- ★ Always fix to a ceiling joist
- ★ 2 core + Earth wiring required
- ★ Isolation switch recommended
- ★ Ensure minimum clearance of 8"/20cm all around blades for effective airflow



Sirocco

Sirocco brings effortless elegance to air movement.

A 117407

Oil Rubbed Bronze
54"/1370mm
Blades: O.R.B.

B 117414

Matt White 54"/1370mm
Blades: Matt White



Whisper Quiet ★★★★★

I did a lot of research into ceiling fans and picked this as it was to be installed in a bedroom and promised to be quiet in operation. I was not wrong. Even at maximum speed it did not keep me awake and the quality shows.

KEY FEATURES AND BENEFITS



Complete remote control system offering 6 speeds in forward & reverse and light on/off/dim. Timer 1/3/6hr



Dimmable LED Light



Low Energy DC motor



Unique Oil Rubbed Bronze finish option



Elegant curved blade style



Longer drop rods available



Use in Summer for cooling and in Winter to re-circulate warm air



Aero



Looking for substantial air movement? Aero delivers.

A 117148

Matt White 56"/1440mm
Blades: Matt White



! Fun Fact: Aero is the biggest air mover in the range at a staggering 8000 cubic feet per minute.

” Beautiful looking fan ★★★★★

I love this fan. Unlike most fans that I've seen, it really is a thing of beauty with smooth, elegant lines and quiet, graceful movement.

KEY FEATURES AND BENEFITS



Complete remote control system offering 6 speeds in forward & reverse and light on/off



LED light. Blanking plate included should light not be required



Low Energy DC motor



The ultimate air mover



Longer drop rods available



Use in Summer for cooling and in Winter to re-circulate warm air

AIRFLOW
8000 CU/FT PER MIN

POWER CONSUMPTION
ON HIGH SPEED 41W



Tau 2

An upgraded version of the ever-popular Tau fan now with 18w LED light.

A 115793

Matt White 50"/1270mm
Blades: Matt White

B 115809

Natural Iron 50"/1270mm
Blades: Natural Iron

C 115786

Natural Iron 50"/1270mm
Light: GX53
Blades: Natural Iron

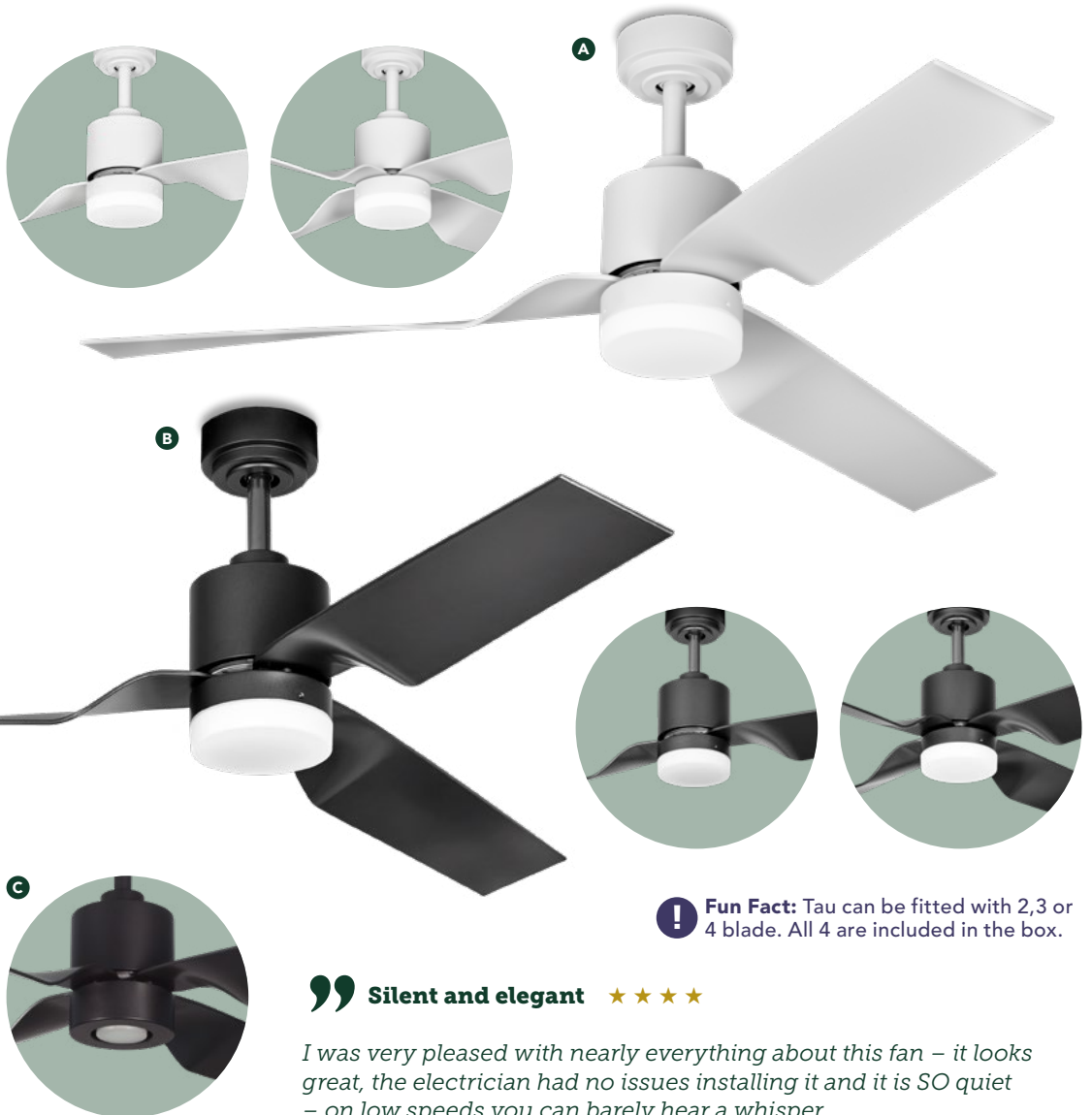

! Fun Fact: Tau can be fitted with 2, 3 or 4 blade. All 4 are included in the box.

” **Silent and elegant** ★★★★★

I was very pleased with nearly everything about this fan – it looks great, the electrician had no issues installing it and it is SO quiet – on low speeds you can barely hear a whisper.

KEY FEATURES AND BENEFITS



Complete remote control system offering 6 speeds in forward & reverse and light on/off



LED Light



Low Energy DC motor



Supplied with 4 blades but can be fitted with 2 or 3 blades if preferred



Longer drop rods available



Use in Summer for cooling and in Winter to re-circulate warm air

AIRFLOW

6750 CU/FT PER MIN

POWER

CONSUMPTION

ON HIGH SPEED 35W

Revolver



A truly unique ceiling fan ideal for when you can't mount a fan centrally in the room.

A 117285

Matt White 12"/30cm
Blades: Matt White



Fun Fact: This ceiling fan oscillates 360 degrees to provide a great area of ventilation.

Brilliant. Exactly what we were looking for ★★★★★

Really pleased with our new fan. It is very quiet, just works, easy to fit, very solid and looks classy.

KEY FEATURES AND BENEFITS



Complete remote control system offering 3 speeds and oscillation control. Timer 2/4/6hr



Optional 360 degree oscillation



Rubberised blades for safety



Unique style for smaller rooms or non-central mounting

AIRFLOW
970 CU/FT PER MIN

POWER CONSUMPTION
ON HIGH SPEED 31W

Prima

A truly versatile ceiling fan – Flush or drop mount, choice of blades sizes, with or without light, it all comes as standard.

A 117162

Matt White 52"/1320mm
Blades: Matt White

B 117247

~~Matt White 42"/1070mm
Blades: Matt White~~

C 117186

Natural Iron
52"/1320mm
Blades: Walnut
Blade Reverse:
Canadian Maple

D 117261

~~Natural Iron 42"/1070mm
Blades: Walnut
Blade Reverse:
Canadian Maple~~

E 117179

Brushed Nickel 52"/1370mm
Blades: Canadian Maple
Blade reverse: Walnut

F 117254

~~Brushed Nickel 42"/1070mm
Blades: Canadian Maple
Blade reverse: Walnut~~

G FLUSH MOUNT

Fan shown flush mount
in different finishes.



” **Great looking and very quiet fan** ★★★★★

We bought this fan for our kitchen/conservatory as we were suffering in the heat of the summer. It looks great, is extremely quiet when running and makes a real difference to the temperature of the room. Absolutely delighted.

KEY FEATURES AND BENEFITS



Complete remote control system offering 3 speeds in forward & reverse and light on/off/dim



18W LED light.



Low Energy DC motor



Available in choice of sizes



Versatile dual mount design



Longer drop rods available



Use in Summer for cooling and in Winter to re-circulate warm air

AIRFLOW

5358 CU/FT PER MIN

POWER

CONSUMPTION
ON HIGH SPEED 73W



Zeta

Eco-friendly elegance refreshingly delivered by Zeta.

A 114970

Brushed Nickel
52"/1320mm
Blades: Walnut
LED Light

B 114994

Brushed Nickel
52"/1320mm
Blades: Silver
LED Light

C 114963

White
52"/1320mm
Blade: White
LED Light

D OPTIONAL COVER



” **Silent in low speed operation** ★★★★★

Silent in low speed operation, installed in our bedroom and you can keep it on all night for a gentle stirring of the air, fantastic!

KEY FEATURES AND BENEFITS



Complete remote control system offering 6 speeds in forward & reverse and light on/off/dim



LED light



Low Energy DC motor



Curved blades for improved air movement



Flush mount only



Use in Summer for cooling and in Winter to re-circulate warm air

AIRFLOW

5387 CU/FT PER MIN

POWER

CONSUMPTION
ON HIGH SPEED 32W



! Fun Fact: Zeta blades are hand carved from sustainable Paulownia wood



Zeta fans are supplied with an optional cover for the light. Ideal if you are using the fan for ventilation only.



Not sure
what size
fan you
need?

See our
FAQs on P45.

Viper Plus

The latest incarnation of the hugely popular Viper ceiling fan.

A 116110

Pewter 54"/1370mm
116059
Pewter 44"/1120mm
Blades Gloss Black

B 116066

White 54"/1370mm
116004
White 44"/1120mm
Blades: Gloss White

C 116080

Stainless Steel 54"/1370mm
116028
Stainless Steel 44"/1120mm
Blades: Maple

D 116103

Stainless Steel 54"/1370mm
116042
Stainless Steel 44"/1120mm
Blades Dark Oak

E 116097

Antique Brass 54"/1370mm
116035
Antique Brass 44"/1120mm
Blades: Dark Oak



Viper Plus Pewter shown here in 44" version with optional flush mount kit

” Well worth the cost ★★★★★

The Viper Plus does not disappoint. Highly efficient, whisper quiet fan gently circulating the air. The design and styling is sharp and it looks incredible in our high ceiling bedroom. Would definitely recommend.

KEY FEATURES AND BENEFITS



Complete remote control system offering 3 speeds in forward & reverse and light on/off/dim



LED light



The ultimate blend of stunning design & exceptional air movement



Can be flush mounted with the use of an additional kit



Longer drop rods available



Use in Summer for cooling and in Winter to re-circulate warm air

AIRFLOW
6600 CU/FT PER MIN

POWER CONSUMPTION
ON HIGH SPEED 105W



! **Fun Fact:** We've been selling the Viper fan in various forms for over 30 years



OPTIONAL EXTRAS

You may have a lower ceiling and require the ceiling fan to be fitted flush rather than with a rod. This can be achieved with a Flush Mount Kit.

333432

Flush Mount Kit – White

333456

Flush Mount Kit – Stainless Steel

333449

Flush Mount Kit – Antique Brass

333470

Flush Mount Kit – Pewter



Blade



Singular Air Movement.

A 115014

White 42"/1070
Blades: White

B 115007

Brushed Aluminium
42"/1070mm
Blades: Silver

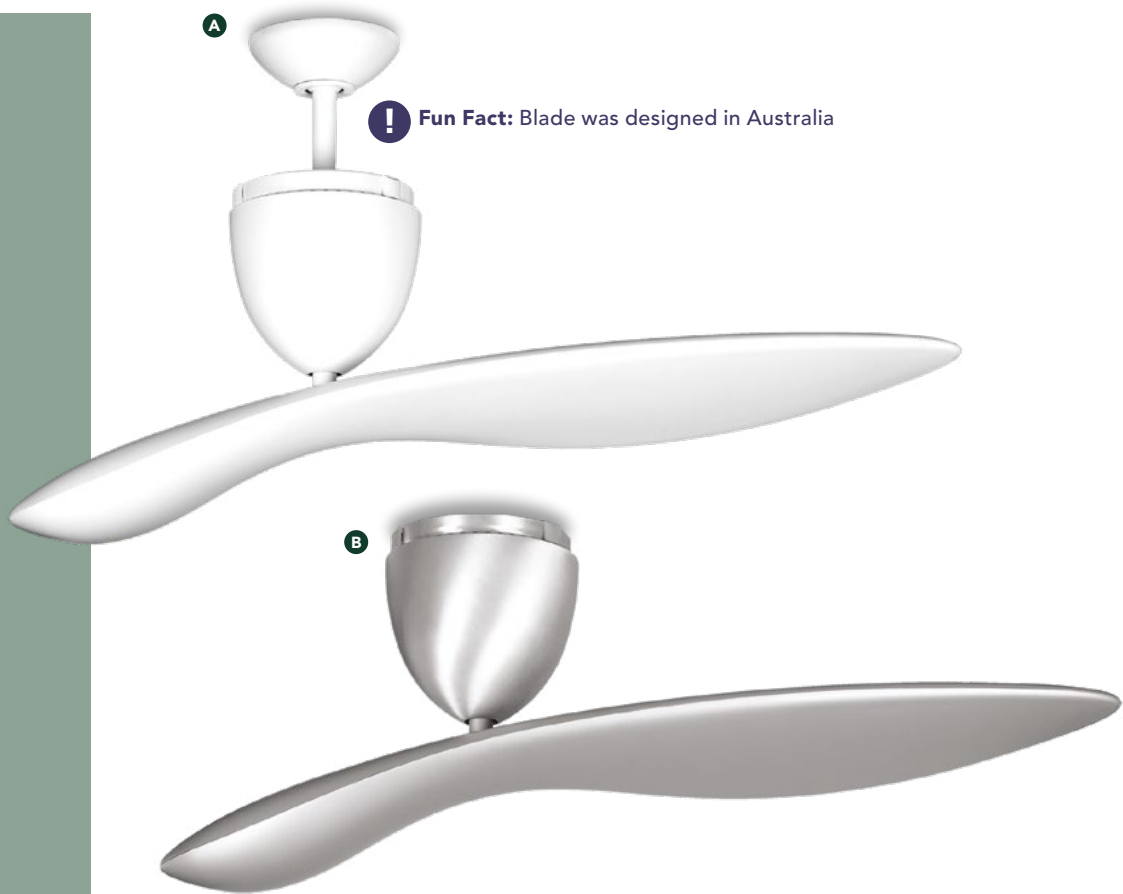

! Fun Fact: Blade was designed in Australia

” Brilliant product ★★★★★

This fan is amazing – we were looking for something a bit more contemporary than normal fans and this fitted the bill perfectly. Very pleased, it looks great and works brilliantly.

KEY FEATURES AND BENEFITS



Complete remote control system offering 3 speeds in forward. No reverse option.



Dual mount – Can be fitted flush to the ceiling or on a drop rod with use of an additional kit



Turning diameter 1372mm



Patented single blade design



International design award winner



Longer drop rods available

AIRFLOW
4100 CU/FT PER MIN

POWER CONSUMPTION
ON HIGH SPEED 60W



Cirrus

Unique blade gives great air movement for a small fan.

A 117346

Matt White 40"/1016mm
Blades: White



” **Brilliant** ★★★★★

Virtually silent, effective and extremely elegant.

KEY FEATURES AND BENEFITS



Complete remote control system offering 3 speeds and light on/off/dim. Timer 2/4/6hr



LED Light



Longer drop rods available



Use in Summer for cooling and in Winter to re-circulate warm air

AIRFLOW

3200 CU/FT PER MIN

POWER

CONSUMPTION
ON HIGH SPEED 50W

Darwin

A beautiful and versatile addition to the range.

A 117353

Brushed Nickel 52"/1320mm
Blades: Vintage Oak

B 117360

Brushed Nickel 44"/1120mm
Blades: Vintage Oak

C 117377

Matt White 52"/1320mm
Blades: Matt White

D 117384

Matt White 44"/1120mm
Blades: Matt White

E OPTIONAL COVER

Optional Light Cover

F FLUSH MOUNT

Darwin shown flush mounted



! Fun Fact: Darwin is offered with our new 'Vintage Oak' blade finish

” **An elegant feature in our conservatory** ★★★★★

Great looking fan, modern, sleek and so quiet. The remote is so easy to use, the light is unobtrusive and the modern, minimalistic design is wonderful. Comes with a great guarantee too!

KEY FEATURES AND BENEFITS



Complete remote control system offering 3 speeds in forward & reverse and light on/off/dim. Timer 2/4/6hr



Dimmable LED light



Sleek 3 bladed design



Available in two sizes 52" & 44" overall span



Longer drop rods available



Use in Summer for cooling and in Winter to re-circulate warm air

AIRFLOW
5400 CU/FT PER MIN

POWER CONSUMPTION
ON HIGH SPEED 65W



Darwin fans are supplied with an optional cover for the light. Ideal if you are using the fan for ventilation only.



Confused about what length drop rod you might need?



See our measuring up guide on P46.

Islander

DM
O

10
years

Bringing that Island breeze into your home.

A 115922

Hammered Black 52"/1320mm
Blades: Walnut







! Fun Fact: Islander's blades are made up of 13 layers of timber



” Whisper Quiet ★★★★★

Having fitted other types of ceiling fans in the past I can say without a shadow of doubt that Fantasia rules. It is solidly built with a whisper quiet fan assembly and perfect balance when rotating. Why would you go anywhere else than Fantasia?

KEY FEATURES AND BENEFITS

-  Wall control operates 3 speeds. No reverse option
-  Unique hammered black finish
-  Die-cast motor housing and canopy
-  12"/30cm drop rod supplied, longer drop rods available
-  Ideal for larger rooms with higher ceilings
-  Air movement 7600cu/ft per minute!

AIRFLOW
7600 CU/FT PER MIN

**POWER
CONSUMPTION**
ON HIGH SPEED 66W

Equally at home outdoors or indoors.

A 114871

Chocolate Brown
52"/1320mm
Light: Patio 2 x 60w ES

B 111665

Chocolate Brown
52"/1320mm
Without Light
Blade: Natural Brown Acrylic

C 114857

Chocolate Brown
52"/1320mm
Light: Florence 3 x 50w G9
Blades: Natural Brown Acrylic

D 221500

Amorie Light Kit
Chocolate Brown
3 x 50w G9
To Suit Palm Fan



! Fun Fact: Palm is IP rated which means it is suited to covered outdoor environments



Great ★★★★★

Worth every penny, so easy to install.

KEY FEATURES AND BENEFITS



Can be upgraded to remote control operation



Independent pull cords operate the 3 speeds of the fan and the light on/off



IP54 rated, perfect for indoor or covered outdoor use



Longer drop rods available



Use in Summer for cooling and in Winter to re-circulate warm air

AIRFLOW
5373 CU/FT PER MIN

POWER CONSUMPTION
ON HIGH SPEED 66W

Gemini

FS

10
years

Iconic pewter finish.

A 111849

Pewter 42"/1070mm
Blades: Gloss Black
Light: Venice 3 x 50w GU10

B 111931

Pewter 42"/1070mm
Blades: Gloss Black

! Fun Fact: Gemini was the first fan to carry the popular Pewter finish

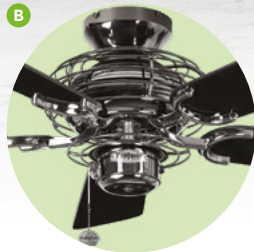

Great Fan ★★★★★

This fan was more than I really wanted to spend but I'm so glad I did. The build quality is amazing, the instructions/wiring is all very detailed and simple. Even on the fastest speed the fan is whisper quiet, the three 50w lights give out plenty of light and can be directed and angled in any direction. It really is worth the money!

KEY FEATURES AND BENEFITS



Can be upgraded to remote control



Independent pull cords operate the 3 speeds of the fan and the light on/off



Complete with Venice light kit



Also available without a light



Flush mounted making it idea for low ceilings (can be converted to drop rod style if required)



Use in Summer for cooling and in Winter to re-circulate warm air

AIRFLOW

4720 CU/FT PER MIN

POWER

CONSUMPTION
ON HIGH SPEED 58W



A 115298

Brushed Aluminium
44"/1120mm
Blades: Matt Silver

B 115311

Brushed Aluminium
44"/1120mm
With Light
Blades: Matt Silver



! Fun Fact: Orion's motor housing is hewn from solid aluminium. It's lightweight and looks great!

” Fantastic Orion ★★★★★

Great product, well packaged, simple to order, simple to install, does a top job & to top it all it looks really cool – excuse the pun!

KEY FEATURES AND BENEFITS



Complete remote control system operates the 3 speeds of the fan and the light on/off/dim



Available with or without integral halogen light



Longer drop rods available



Use in Summer for cooling and in Winter to re-circulate warm air

AIRFLOW

4100 CU/FT PER MIN

POWER

CONSUMPTION
ON HIGH SPEED 42W

Classic

DM 10 years

Perfect for traditionally styled interiors.

A 110019

Polished Brass 52"/1370mm
Blades: Matt Mahogany/
Matt Oak & Cane

B 110033

Gloss White 52"/1370mm
Blades: Matt White &
Cane/Matt White

C 110224

Antique Brass 52"/1370mm
Blades: Matt Oak & Cane/
Matt Mahogany

D 110460

Gloss Black 52"/1370mm
Blades: Matt Black/
Matt Mahogany

LIGHTING OPTIONS

FLORENCE

220282 Polished Brass
220268 Antique Brass



AMORIE

221463 Gloss White
221494 Matt Black



! Fun Fact: Classic has been in the Fantasia range for over 30 years

” My third purchase with no hesitation ★★★★★

This is the third Fantasia unit purchased; bought it on the grounds that the two previous units have worked faultlessly and silently for some years now. They don't vibrate or buzz, nor do they wobble about like cheap ones always do. They are not by any means the lowest cost items, BUT, they work faultlessly and silently and are a delight to sleep under, you get a gentle breeze, but no buzzing, whirring etc.

KEY FEATURES AND BENEFITS



Can be upgraded to remote control operation



Pull cord operates the 3 speeds of the fan, longer drop rods also available



Dual mount fixing means fan can be fitted with or without drop rod



Longer drop rods available



Use in Summer for cooling and in Winter to re-circulate warm air

AIRFLOW

6165 CU/FT PER MIN

POWER

CONSUMPTION
ON HIGH SPEED 64W



Titan

The largest ceiling fan in our range.

TITAN LINEAR

A 117605

Brushed Titanium
LED Light
Remote Control
84"/214cm overall span
12" Drop rod Included
Also available without light

B 117599

Brushed Titanium
Remote Control
84"/214cm overall span
12" Drop rod Included

TITAN TURBINE

C 117582

Brushed Titanium
LED Light
Remote Control
82"/209cm overall span
12" Drop rod Included
Also available without light

D 117575

Brushed Titanium
Remote Control
82"/209cm overall span
12" Drop rod Included

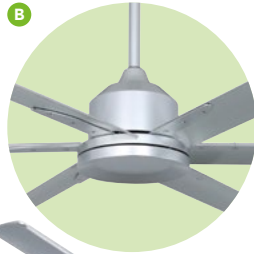

! Fun Fact: The Titan Linear & Titan Turbine Fans are HUGE with an overall span of 82" and 84" respectively



KEY FEATURES AND BENEFITS



Complete remote control system offers 6 speeds in forward and reverse and light on/off



LED light



Very high airflow at very low power consumption



Longer drop rods available



Use in Summer for cooling and in Winter to re-circulate warm air

AIRFLOW

13367 CU/FT PER MIN

POWER

CONSUMPTION
ON HIGH SPEED 45W

Kompact

DM  10 years

The fan with the smallest overall span!

A 115557

Brushed Nickel 28"/711mm
Blades: Maple
Blade Reverse: Dark Oak

B 115540

Gloss White 28"/711mm
Blades: White



! Fun Fact: Kompact has the smallest overall turning span of any ceiling fan we make. It's just 28"/711mm



” **Fantasia Kompact Fan** ★ ★ ★ ★

Very pleased. Bought two of these fans for our bedrooms. They look smart and are quiet so can sleep peacefully.

KEY FEATURES AND BENEFITS



Independent pull cords operate the 3 speeds of the fan and the light on/off



LED Light



Can be mounted flush or with a drop rod



Longer drop rods available



Use in Summer for cooling and in Winter to re-circulate warm air



Ultra slim design for smaller spaces e.g loft conversions and small bedrooms

AIRFLOW
4280 CU/FT PER MIN

POWER CONSUMPTION
ON HIGH SPEED 60W

Verona Light Kit

A new light kit ideal for the mayfair ceiling fan.

A 222569

White

B 222576

Stainless Steel
Light kit only

The Verona Light kit
is shown here on the
Mayfair Fan



! Fun Fact: Ideal for use on Mayfair or Capri fans

KEY FEATURES AND BENEFITS



Pull Cord Operation



18w LED light



Overall diameter 210mm



Designed to fit Classic, Mayfair & Capri Ceiling Fans

Capri and Capri Combi

FS

10 years

A versatile addition to any room.

A 110200

Gloss White 36"/914mm
Blades: Matt White

B 110255

Stainless Steel 36"/914mm
Blades: Washed Oak
Blade Reverse: Silver

C 110521

Gloss White & Stainless Steel 36"/914mm
Blades: Matt White

D 110187

Stainless Steel 36"/914mm
Light: Belmont 3 x 60w SES
Blades: Silver
Blade Reverse: Washed Oak

E 110194

Gloss White 36"/914mm
Light Belmont 3 x 60w SES
Blades Matt White

F 110538

Gloss White & Stainless Steel 36"/914mm
Light: Belmont 3 x 60w SES
Blades Matt White

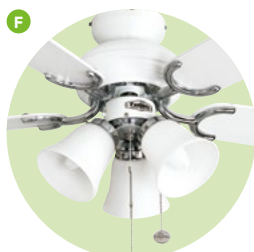

! Fun Fact: Tried & Tested Capri was originally introduced to the range in 1990

” **What a difference!!** ★★★★★

Whisper quiet and easy to install, this fan has really helped my sleep pattern. I leave it on the low setting overnight, no sound just air moved and refreshed. Perfect.

KEY FEATURES AND BENEFITS



Can be upgraded to remote control



Independent pull cords operate the 3 speeds of the fan and light on/off



Flush mounted making it idea for low ceilings (can be converted to drop rod style if required)



Use in Summer for cooling and in Winter to re-circulate warm air



Compact design works particularly well in smaller rooms

AIRFLOW

4720 CU/FT PER MIN

POWER

CONSUMPTION
ON HIGH SPEED 45W

In the Mayfair range you will find a finish to suit any room décor.

A 111825

Gloss White 42"/1070mm
Light: Amorie 3 x 60w G9
Blades: Gloss White

B 110644

Gloss White 42"/1070mm
Blades: Gloss White



” **SILENT AND BLISSFUL NIGHTS SLEEP** ★★★★★

We already have one of these fans in our bedroom, this was a second purchase for our son's room. The silent running and gentle movement of air ensures a cool, quiet night's sleep.

KEY FEATURES AND BENEFITS



Can be upgraded to remote control



Independent pull cords operate the 3 speeds of the fan and light on/off



Finishes to suit any room



Flush mounted making it ideal for low ceilings (can be converted to drop rod style if required)



Use in Summer for cooling and in Winter to re-circulate warm air

AIRFLOW

5200 CU/FT PER MIN

POWER

CONSUMPTION
ON HIGH SPEED 50W

Mayfair

C 115496

Stainless Steel 42"/1070mm
Light: Amorie 3 x 60w G9
Blades: Dark Oak

D 111757

Chrome 42"/1070mm
Light: Sorrento 3 x 50w GU10
Blades: Gloss Black

E 111962

Antique Brass 42"/1070mm
Light: Florence 3 x 60w G9
Blades: Gloss Oak & Cane
Blades Reverse:
Gloss Mahogany

F 110057

Antique Brass 42"/1070mm
Blades: Gloss Mahogany
Blade reverse: Gloss
Oak & Cane

G 110651

Chrome 42"/1070mm
Blades: Gloss Black

H 110507

Matt Black 42"/1070mm
Blades: Matt Black

I 110606

White & Stainless
Steel 42"/1070mm
Blades: White

J 110996

Matt Black 42"/1070mm
Light: Amorie 3 x 60w G9
Blades: Matt Black

J 110009

White & Stainless
Steel 42"/1070mm
Light: Amorie 3 x 60w G9
Blades: White



! Fun Fact: One of the longest serving and still most popular ceiling fans we do!



” Cool ★★★★★

I was a little apprehensive when ordering this fan for our kitchen re quality, noise and installation.... It all went very well: delivery great, product high quality; installation easy and looks great.

KEY FEATURES AND BENEFITS



Can be upgraded to remote control



Independent pull cords operate the 3 speeds of the fan and light on/off



Finishes to suit any room



Flush mounted making it idea for low ceilings (can be converted to drop rod style if required)



Use in Summer for cooling and in Winter to re-circulate warm air

OPTIONAL EXTRAS

As standard this fan is controlled by manual pull cords. Why not add a remote control for cordless operation of the 3 speeds of the ceiling fan and the light on/off/dim functions?

You may have a higher ceiling and require the ceiling fan to be fitted on a drop rod rather than flush. A drop rod and conversion kit will be required to achieve this.

Please see our price list or website for product codes.

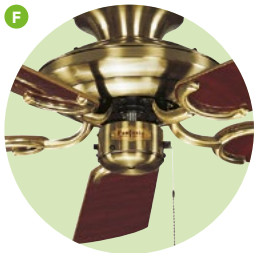

117520

White 42"/107cm
Blades: Matt White
Cool White LED Light

117537

White 42"/107cm
Blades: Matt White
Warm White LED Light

117551

Brushed Nickel 42"/107cm
Blades: Dark Oak
Cool White LED Light

117568

Brushed Nickel 42"/107cm
Blades: Dark Oak
Warm White LED Light



Fairbanks can be flush mounted if preferred



Fun Fact: This fan can be flush mounted OR drop mounted depending on ceiling height

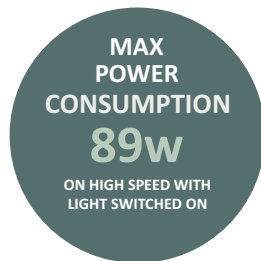

KEY FEATURES AND BENEFITS

- Quality at a great price
- Remote control system offering 3 speeds in forward & reverse and light on/off/dim, and 2hr, 4hr, 8hr switch off timer
- 9w Dimmable LED light
- LED Light Choice of warm or cool white light bulbs. Specify when ordering
- Reverse Switch on Motor - Use in Summer for Cooling and in Winter to re-circulate warm air
- Longer drop rods available

Ideal for Bedrooms, Living Rooms, Orangeries and Conservatories

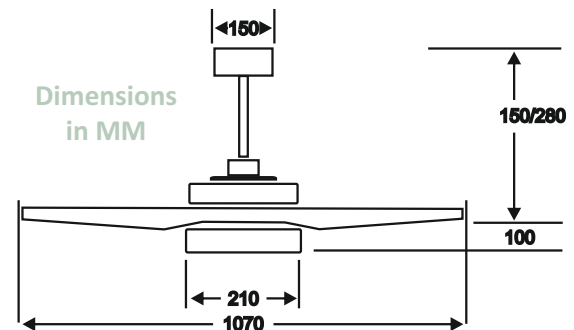

INSTALLATION

- ★ Always fix to a ceiling joist
- ★ 2 core + Earth wiring required
- ★ Isolation switch recommended
- ★ Ensure minimum clearance of 8"/20cm all around blades for effective airflow

For value for money the Neptune can't be beaten.

A 115847

White 54"/1370mm
115861
White 44"/1120mm
Blades: White

B 115854

Brushed Nickel 54"/1370mm
115878
Brushed Nickel 44"/1120mm
Blades: Silver









! Fun Fact: Neptune can be flush or drop mounted straight out of the box

“ Neptune LED fan, great ★★★★★

Fan is very good quality and runs virtually silently on all speeds. Remembers the last speed when the power is switched off and back on so good for wiring through wall switch too. LED light is nice a bright and good enough for a 20sqm room.

KEY FEATURES AND BENEFITS

-  Complete with remote control to operate the 3 speeds and light on/off/dim
-  LED Light
-  Dual Mount – This fan can be mounted flush or drop rod style
-  Available in two sizes 54"/1370mm & 44"/1120mm
-  Ideal for larger rooms
-  Use in Summer for cooling and in Winter to re-circulate warm air

AIRFLOW
5300 CU/FT PER MIN

POWER CONSUMPTION
ON HIGH SPEED 58W

A versatile addition to any room.

A 114239

Brushed Nickel 42"/1070mm
Blades: Maple
Blade Reverse: Dark Oak
Light: 3 x 60w SES

B 114192

Polished Brass 42"/1070mm
Blades: Matt Oak & Cane
Blade Reverse: Mahogany
Light: 3 x 60w SES

C 110477

White 42"/1070mm
Blades: Matt White & Cane
Blade Reverse: Matt White
Light: 3 x 60w SES

D 110095

White 42"/1070mm
Blades: Matt White
Blade Reverse: Matt White & Cane
No Light







! Fun Fact: Belaire is unique in the decorative range as it comes with 2 lengths of drop rod in the box

“ EXCELLENT PRODUCT AND SERVICE ★★★★★

Robust and easy to assemble and install. Quiet and effective in operation and good value.

KEY FEATURES AND BENEFITS

-  Can be upgraded to remote control
-  Independent pull cords operate the 3 speeds of the fan and light on/off
-  DM Dual Mount – This fan can be mounted flush or drop rod style
-  6"/15cm & 12"/30cm drop rods are included with the Belaire Fan. Longer rods are also available
-  Use in Summer for cooling and in Winter to re-circulate warm air

AIRFLOW
4430 CU/FT PER MIN

POWER CONSUMPTION
ON HIGH SPEED 45W

Two brand new great value entry level models.

A 117452

Moreno 42"/1070mm
117469
Moreno 36"/920mm

Light: 1 x 60w SES
Blades: White

B 117483

Montana 42"/1070mm
117490
Montana 36"/920mm

Light: 3 x 60w SES
Blades: White



! Fun Fact: These new fans supersede the Rio & Rimini which were in the range for over 30 years

” Brilliant Fan ★★★★★

Great value, although very slightly noisier than the Mayfair fans we have from the Fantasia range. Given the price difference, it is a minor difference – still sturdy, well-built and attractive fan, and also the perfect size for our small room. Would buy from this range again, particularly if price was a concern.

KEY FEATURES AND BENEFITS



Can be upgraded to remote control



Independent pull cords operate the 3 speeds of the fan and light on/off



Dual Mount – This fan can be mounted flush or drop rod style



Longer drop rods available



Use in Summer for cooling and in Winter to re-circulate warm air

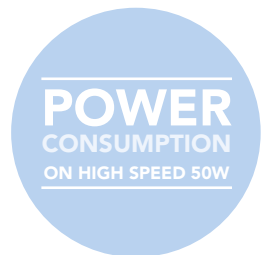

Compact and close coupled.

A 111573

White 30"/762mm
Light: 1 x 60w SES Golf Ball
Blades: White

B114390

Brushed Nickel 30"/762mm
Light: 1 x 60w SES Golf Ball
Blades: Dark Oak



! Fun Fact: One of the 'flushiest' fans we make – Ideal for low ceilings



” Unobtrusive white fan ★★★★★

Ordered this fan for the bedroom as the hot evenings were becoming unbearable. The white Atlanta 30" ceiling fan was just the ticket. I wanted a close coupled fan with no drop rod, with three speeds and the discrete light it's the ideal fan.

KEY FEATURES AND BENEFITS



Can be upgraded to remote control



Independent pull cords operate the 3 speeds of the fan and light on/off



Dual Mount – Can be fitted with or without drop rod



Use in Summer for cooling and in Winter to re-circulate warm air

AIRFLOW

4430 CU/FT PER MIN

POWER

CONSUMPTION
ON HIGH SPEED 45W

Great for warehouses and offices with high ceilings.

A 111870

White 36"/920mm
Blades: White
12"/30cm Drop Rod included

B 111887

White 48"/1220mm
Blades: White
12"/30cm & 24"/60cm
drop rods included

C 111894

White 56"/1420mm
Blades: White
12"/30cm & 24"/60cm
drop rods included



KEY FEATURES AND BENEFITS



Wall Control options available



Efficient Air Movement



Minimum 10ft/3m floor to blade clearance required for metal bladed fans



Use in Summer for cooling and in Winter to re-circulate warm air. Wall control required for reverse function

CONTROL OPTIONS



333029
SIC-1
Controls 1 x fan,
forward only
Max 100w



333036
RVO-1
Controls 1 x fan,
forward and reverse
Max 100w



331674
RVO-5
Controls up to 5 x fans,
forward and reverse
Max 400w

**NOTES: A wall control will be required to operate commercial fans.
We also do not recommend the use of commercial ceiling fans for domestic installations.**

Ceiling fan reverse function

Look up at your ceiling fan. If it is spinning anti-clockwise then it is Summer (cooling) rotation. If it is spinning clockwise then it is Winter (warming) rotation.

A Ceiling Fan is not just for Summer.

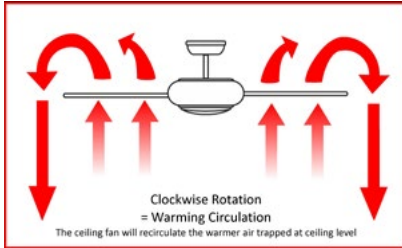

Think about heating the rooms in your house. Central heating systems heat the room from the top down. The upper third of your room will be warm before the lowest third.

The problem is that we humans spend the majority of our time in the lower third of the room, either standing, sitting or lying down.

Rooms with vaulted or pitched ceilings can be even worst in terms of heating. The heat gathers higher up so it takes longer to get to you at ground level.

The solution to this situation is to disrupt that warm air with a ceiling fan. All Fantasia Ceiling Fans (with the exception of the Blade fan and Islander Fan) have a reverse function. This is either activated with a manual switch on the motor itself, or, in some cases the reverse function is controlled with the remote-control handset.

A ceiling fan spinning slowly in reverse will help to push heat downward and make the central heating system more efficient.

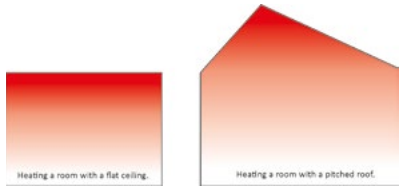

Controls – 2 year warranty

2 years

A REMOTE CONTROL

331759

This is a popular way of controlling our ceiling fans and lights. The remote control consists of a handset and receiver and can be installed in any of our fans.

B WHITE

334002 – Fan speed Control

334071 – Lighting Dimmer

334149 – LED Lighting Dimmer

C POLISHED BRASS

334019 – Fan speed Control

334088 – Lighting Dimmer

334156 – LED Lighting Dimmer

D SATIN STAINLESS STEEL

334026 – Fan speed Control

334095 – Lighting Dimmer

334163 – LED Lighting Dimmer

E BLACK NICKEL

334033 – Fan speed Control

334101 – Lighting Dimmer

334170 – LED Lighting Dimmer

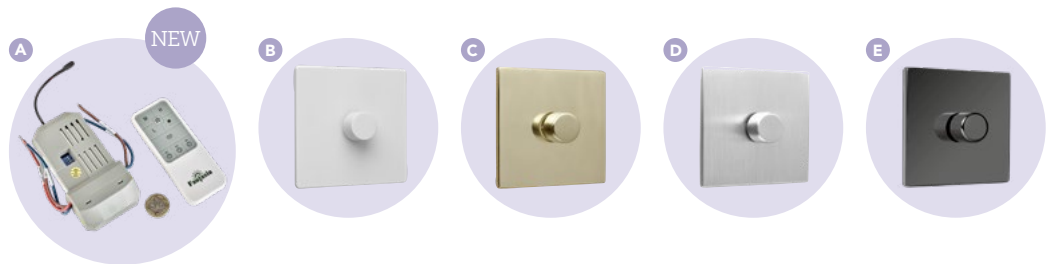

TECHNICAL INFORMATION

Fan Speed Control

Fits into a 35mm deep single gang box. Controls 3 fan speeds only. Maximum power rating is 200 watts. Requires twin and earth cable between fan and control. Please note you will need 1 controller per fan.

Lighting Dimmer

Fits into a 35mm deep single gang box. This standard tungsten/halogen lighting dimmer controls the light on/off/dim. Maximum power rating 400watts. Requires twin and earth cable between light and control.

LED Lighting Dimmer

Fits into a 35mm deep single gang box. This LED lighting dimmer controls the light on/off/dim when only LED light bulbs are fitted. Maximum power rating 100watts. Requires twin and earth cable between light and control.

Note: Only Fantasia LED light bulbs should be used with Fantasia LED lighting dimmers.

Only Fantasia wall controls can be used to control fan motors. A standard light dimmer used on a Fantasia fan motor will cause it to buzz.

Note: These wall controls cannot be used with DC motors or Viper Plus.

All Fantasia Control units including the remote control carry a 2 year limited warranty. They do not switch the fan from forward to reverse. This must be done with the manual reverse switch on the fan itself.

1
year

Vintage Fans

Technical information

- Motor: 50w 220-240v 50hz
- Speeds: 3
- Head: Optional Oscillation
- 12"/300mm diameter
- Dimensions(cm) 42(h)x34(w)x22(d)

A 119654

Vintage Fan Blue
12"/300mm

B 119630

Vintage Fan Black
12"/300mm



1
year

USB Fans

Technical information

- Motor: 3w – USB power point required
- Speeds: 2
- Head: Manual Tilt
- 6"/150mm head diameter
- Dimensions (cm) 22(h)x19(w)x18(d)

A 119708

Black/White

B 119722

Green/White

C 119715

Blue/White



1
year

Whirlwind Desk Fan

Technical information

- Motor: 45w 220-240v 50hz
- Speeds: 3
- Head: Optional Oscillation, Manual Tilt
- 7"/180mm head diameter
- Dimensions(cm) 34(h)x29(w)x20(d)

A 119760

Black 7"/180mm



1
year

Cubix Heater

Technical information

- 1800/900w
- Thermostatic
- Dimensions(cm) 26(h)x14(w)x17(d)

A 120001

Silver



FAQ's

Q. WHAT SIZE FAN DO I NEED?

A. When choosing a ceiling fan it is important to remember that it is more relaxing and efficient to run a larger fan on a lower speed than a small fan on a higher speed. Fantasia Fans range from 28"/71cm to 56"/144cm in diameter to suit any installation. In order to generate air movement, it is very important that you have sufficient clearance from the tip of the blades to the slope of the ceiling or any other obstruction such as a beam.

Room Size	Fan Size
8ft x 10ft (2.43m x 3m)	28"/30" (71cm/76cm)
12ft x 12ft (3.65m x 3.65m)	36"/42" (91cm/107cm)
15ft x 12ft (4.57m x 3.65m)	42"/52" (107cm/132cm)
20ft x 14ft (6.1m x 4.27m)	52"/54"/56" (132cm/137cm/144cm)

For larger rooms we recommend 2 or more fans. Should the room have above average heat conditions e.g. conservatory or south facing bedroom, then increase the fan size to the next size up.

Rooms with ceilings higher than 8ft 2" (2.5m) will require a longer drop rod to lower the fan to a suitable level of operation.

See our measuring-up guide opposite.

Q. IS INSTALLATION DIFFICULT?

A. A ceiling fan can be wired into an existing lighting circuit (two core and earth) and is a simple DIY job. We recommend that installation is carried out in accordance with National Electrical Codes. The fixing point for the ceiling fan must be strong enough to support 4 times the fan's stationary weight. If you are in any doubt then consult a qualified electrician.

Q. HOW DO I OPERATE THE FAN SPEEDS?

A. Your Fantasia fan will be supplied with either a remote control, a stepped wall speed control or an integral pull switch with chain. The remote control consists of a handset and receiver unit. All our pull-cord operated fans can be upgraded to either wall control or remote control and this can be done at a later date if required. A wall mounted variable dimmer switch must not be used to adjust fan speeds.

IMPORTANT – Ensure power has been isolated for at least 2 hrs before commencing work on a ceiling fan. Only attempt ceiling fan maintenance if you are confident with electrical products. If you are in any doubt then consult a qualified electrician.

We make every effort to keep product information up to date but please note that specifications and data are subject to change without notice. Fantasia Dist Ltd accepts no liability for any loss caused by inaccurate information.

Fantasia Ceiling Fans have enough electrical cable installed to allow for an 18"/46cm rod. If you are installing a longer rod on the fan then you may wish to purchase a cable extension pack. Ceiling Fan Blades, Light Shades & Light Bulbs are also available, please see our website for details.

For technical advice and customer service please call us on **01959564440**, email technical@fantasiaceilingfans.com or use the LiveChat facility on our website www.fantasiaceilingfans.com.

Q. HOW DO I OPERATE THE FAN LIGHT?

A. If the fan has a light then this will be operated by either the remote control, a wall switch or a separate integral pull switch with chain. The fan and light can always be operated independently.

Q. WHAT FAN ACCESSORIES MIGHT I NEED?

A. We offer a wide range of accessories to cater for every type of installation. Flush mounted fans can be converted to drop rod mount using a Conversion Kit and longer drop rods ranging from 12"/30cm to 72"/183cm are available for conservatory installations or rooms with high ceilings. A Big Strip Fastener can be useful when attaching a fan to a narrow beam or conservatory crossbar. Light Kits are available to fit to ceiling fans that come without a light as standard. We can even supply a ceiling fan Blade Duster!

Q. ARE FANS NOISY AND DO THEY WOBBLE?

A. Some competitors' fans are noisy and wobble because they are made from inferior materials. Fantasia fan motors are larger, and are of silicon steel construction with double sealed bearings, ensuring long, quiet, reliable and maintenance-free operation. Fantasia fans move more air, run quietly and, even when fitted with a drop rod, are very stable.

Q. HOW MUCH DOES A FAN COST TO RUN?

A. Fantasia fans run off the standard lighting circuit (5 amp) and are very economical to run. The winter setting on our fans re-circulates the warm air trapped at ceiling level, eliminating cold spots and draughts and distributing room heat without creating a cooling breeze. Used correctly, a ceiling fan can save as much as 10% on energy bills during the winter months.

Q. WHAT IS COVERED UNDER THE WARRANTY?

A. Fans in the Elite Range and the Fantasia Range have a 10 year motor warranty during which time we will repair or replace defective product. Fans in the EuroFans Range have 5 year motor warranty. All remote control systems carry a 2 year warranty. Costs such as electricians' fees, hiring of specialist equipment etc is specifically excluded. You must retain your proof of purchase.

Q. DOES THE FAN REQUIRE ANY MAINTENANCE OR CLEANING?

A. All Fantasia fans have permanently sealed bearings, double lacquered surfaces and do not require maintenance. An occasional light dusting with a soft cloth is all that is required although it is suggested that all fixings/screws are tightened annually. Do not use any liquids or polishers on any part of your ceiling fan as this may cause damage.

Measuring Up Guide



Measuring up for a ceiling fan installation

Flush Mount

A flush mount ceiling fan can only be mounted on a flat ceiling

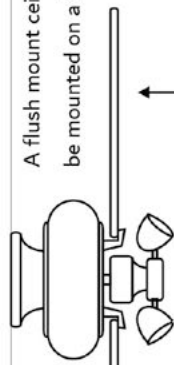

Blade tips should be at least 15cm from the nearest obstacle in any direction, eg tie bar, wall or roof beam

Ceiling fans blade should be at least 229cm from the floor

To convert a flush mount fan to a drop mount fan you will need a conversion kit

To mount a ceiling fan in a conservatory a 'Big Strip Fastener' would be useful. See page 45 of the Fantasia brochure

Drop Mount



Different rod lengths are available for most fans

Drop mounted fans can be mounted on a sloping ceiling up to 35 degrees in angle

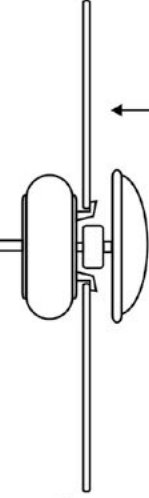

Blade tips should be at least 15cm from the nearest obstacle in any direction, eg tie bar, wall or roof beam

Ceiling fan blades should be a minimum of 229cm and a maximum of 290cm above the floor to be safe and effective

Mounting Options/Spare Parts

It's important to understand the different mounting options for different Ceiling Fans in our range. Your ceiling height or angle may dictate that you need a flush mount (no drop rod, ceiling fan fits flush to the ceiling) or a drop mount (ceiling fan hangs from a drop rod) installation. Some ceiling fans can only be flush mounted, some only drop mounted, others can be converted, either with the use of extra parts or with the use of parts in the box that come with the fan. This guide should help distinguish which fans can be mounted in which ways.

FLUSH MOUNT ONLY FO

This fan can only be mounted flush to the ceiling. **Zeta Fan.**

DUAL MOUNT DM

Can be flush or drop mounted using parts supplied in the box. **Prima, Classic, Kompact, Neptune, Belaire, Atlanta, Darwin, Breeze, Moreno, Montana.**

How do I do it? All of the parts to fit the fan drop or flush mount are in the box. Just bear in mind that you may require a drop rod longer than the one supplied, typically 150mm.

DROP MOUNT ONLY DMO

Different length drop rods are available but there is no flush mount option for these ceiling fans. **Aero, Tau, Splash, Islander, Sigma, Phoenix, Orion, Spinnaker, Palm, Revolver, Sirocco, Tau 2.**

DROP MOUNT STANDARD DMS

This fan is drop mount as standard but can be flush mounted using extra parts. **Viper, Viper Plus.**

How do I do it?
Order a 'Flush Mount Kit' in the same finish as the ceiling fan. This kit includes a different canopy and fixing bracket in order to enable flush mounting.



Flush Mount Kit

FLUSH MOUNT STANDARD FM

This fan is flush mount as standard but convertible to drop mount with extra parts. **Mayfair, Gemini, Capri, Blade.**

How do I do it? In order to convert one of the above fans to drop mount then you will need to order a conversion kit in the matching finish and also the require length of drop rod.

Flush mount



Drop mount



Drop Rods



Conversion Kit

BIG STRIP FASTENER BSF

This can be used to aid the fitting of any ceiling fan in a conservatory. It allows for extra fixings into a ridge plate. Order one with your ceiling fan if getting a good fixing point may be an issue.



441199
140x50mm

SPARE PARTS

A Embossed pull chain medallion

440109 – Polished brass
440116 – Pewter
440123 – Chrome

F Reverse Switch

441038 – White
441045 – Black

Viper Reverse Switch

441069 – White
441076 – Black

B One metre extension chain

330226 – Polished Brass
330547 – Pewter
330233 – Chrome

G Speed Capacitor

440857 – This controls the 3 speeds of the ceiling fan.

C Cable Extension Pack

442066 – 30"/76cm Rods
442073 – 48"/122cm Rods
442080 – 72"/183cm Rods

H Start Capacitor

440826 – This starts the fan moving.

D Light Switch

440703 – Polished Brass
440734 – Pewter
440727 – Chrome

I Blade duster

449003

E Speed Switch

440611 – Polished Brass
440635 – Pewter
440628 – Chrome

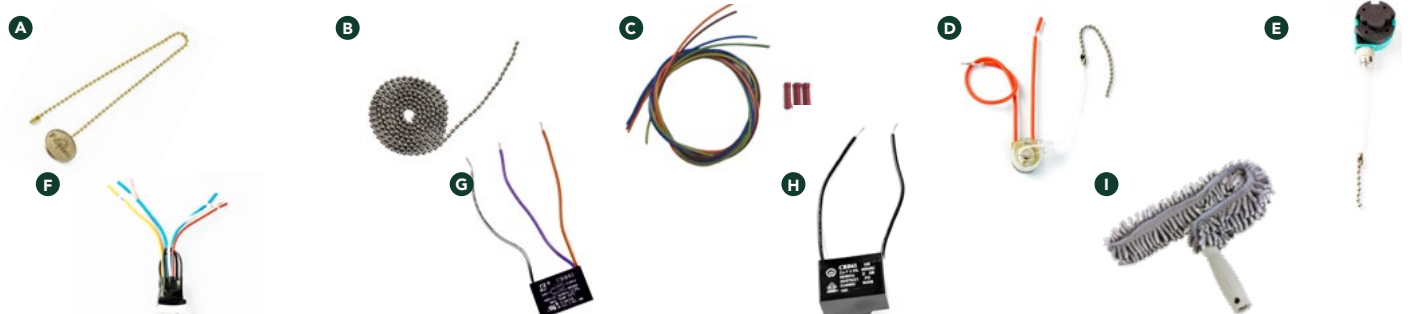

Fantasia Distribution Ltd – Technical Specification 2020				RPM			Weight in KG			Fan Dimensions				Box Size mm									
	Control Method	Light Type	Light Wattage	Lumens	Bulb Inc?	Motor Rating (W)	CU Ft per Min (high)	High	Med	Low	Gross	Net	Overall Span	Ceiling to Blade	Overall Fan Drop	Light Drop	Canopy Width	Drop Rod Type	W	L	H	Warranty	
Aero	Remote	LED 4000k	18	1310	Array	41	8000	195	115	60	9.5	8.5	1440	320	360	40	150	NON STD	395	765	265	10	
Atlanta	Pull Cord	1 x SES (golf)	60	310	No	60	2595	263	205	151	5.8	5.3	760	160/260	280/380	130	130	STD 22MM	400	240	210	5	
Belaire	Pull Cord	n/a	n/a	n/a	n/a	60	3571	200	135	87	5.6	5.2	1070	180	225	n/a	150	STD 22MM	240	410	260	5	
Belaire Combi	Pull Cord	3 x SES	3 x 60	1590	No	60	3571	200	135	87	7.2	6.2	1070	180	225	145	150	STD 22MM	265	640	280	5	
Blade (2 x Boxes)	Remote	n/a	n/a	n/a	n/a	60	4083	148	105	72	6.1/3.2	4.5/2.1	1070	205	365	n/a	210	STD 22MM	1150/550	230/254	160/275	10	
Breeze	Remote	LED 2700k	22	1540	n/a	26	4000	185	125	110	5.6	7.0	1112	290	395	90	130	STD 22MM	590	254	275	10	
Capri	Pull Cord	n/a	n/a	n/a	n/a	45	4725	200	140	85	5.4	4.8	910	160	221	n/a	130	STD 22MM	230	370	260	10	
Capri Combi	Pull Cord	3 x SES	3 x 60	1590	No	45	4725	200	140	85	6.3	5.5	910	160	221	125	130	STD 22MM	300	510	290	10	
Citrus	Remote	LED	18	1674	n/a	50	3200	245	127	130	10.0	8.1	1016	205	305	35	170	STD 22MM	562	638	262	10	
Classic	Pull Cord	n/a	n/a	n/a	n/a	64	6165	199	127	88	7.0	6.3	1320	240/350	325/370	n/a	133	STD 27MM	270	520	250	10	
Commercial 36	Wall Control	n/a	n/a	n/a	n/a	45	5000	271	247	145	5.2	4.5	910	470	515	n/a	148	NON STD	240	540	210	2	
Commercial 48	Wall Control	n/a	n/a	n/a	n/a	65	6300	290	189	102	7.2	6.4	1220	470	515	n/a	148	NON STD	630	540	270	2	
Commercial 56	Wall Control	n/a	n/a	n/a	n/a	68	6800	295	201	105	7.7	6.9	1440	470	515	n/a	148	NON STD	630	n/a	270	250	2
Darwin	Remote	LED Dim	15	900	n/a	65	5400	209	172	97	7.9	6.7	1320	257	318	38	130	STD 27MM	627	265	248	10	
Gemini	Pull Cord	3 x GU10	3 x 50	720	Yes	45	4725	200	141	89	7.2	6.3	1070	190	260	90	130	STD 22MM	290	490	330	10	
Islander	Wall Control	n/a	n/a	n/a	n/a	66	7600	292	268	167	11.8	10.5	1420	450	515	n/a	155	STD 22MM	330	636	288	10	
Kompact	Pull Cord	LED 4000k	18	1310	n/a	56	4280	290	249	209	5.8	5.2	700	175	290	90	130	STD 22MM	270	465	278	10	
Mayfair	Pull Cord	n/a	n/a	n/a	n/a	50	5216	210	140	86	6.1	5.5	1070	165	240	n/a	150	STD 22MM	280	400	280	10	
Mayfair Combi	Pull Cord	3 x G9	3 x 60	1070	Yes	50	5216	210	140	86	7.4	6.2	1070	165	240	100	150	STD 22MM	310	440	310	10	
Montana 42	Pull Cord	3 x E14	3 x 60	1590	No	50	2300	105	140	80	5.4	6.4	1070	310	450	190	130	STD 22MM	438	260	240	5	
Montana 36	Pull Cord	3 x E14	3 x 60	1590	No	50	2300	220	160	95	5.3	6.3	960	310	450	190	130	STD 22MM	438	260	240	5	
Moreno 42	Pull Cord	1 x E14	60	420	No	50	2300	195	140	80	5.8	4.8	1060	310	425	105	130	STD 22MM	452	257	280	5	
Moreno 36	Pull Cord	1 x E14	60	420	No	50	2500	220	160	95	5.6	4.6	960	310	425	105	130	STD 22MM	452	257	280	5	
Neptune 54	Remote	LED 3000k	20	940	Yes	75	5300	208	140	84	10.5	9.3	1320	170/315	230/375	38	146	STD 27MM	360	630	270	5	
Neptune 44	Remote	LED 3000k	20	940	Yes	75	5100	268	192	94	10.4	9.2	1120	170/315	230/375	38	146	STD 27MM	360	630	270	5	
Orion	Remote	n/a	n/a	900	n/a	43	4100	215	187	104	10.4	8.7	1120	260	310	70	170	STD 27MM	340	610	370	10	
Palm	Pull Cord	n/a	n/a	n/a	n/a	66	5373	209	149	93	11.0	10.0	1320	360	430	120	130	STD 22MM	330	560	440	10	
Phoenix	Remote	1 x J Type Hal	60	850	Yes	64	4329	257	145	76	8.3	7.0	1070	280	300	80	140	STD 22MM	270	550	280	10	
Prima	Remote	LED 3000k	18	980	n/a	73	5358	184	128	74	10.1	9.2	1320/1070	320	390	40	150	STD 27MM	645	275	260	10	
Revolver	Remote	n/a	n/a	n/a	n/a	31	970	1250	1000	760	5.3	4.0	300	350	525	n/a	140	NON STD	376	438	447	10	
Sirocco	Remote	LED Dim	20	1200	Array	35	7100	150	115	75	10.9	8.4	1370	218	308	22	140	STD 27MM	887	435	248	10	
Tau 48	Remote	LED GX53	10	800	Yes	35	6750	198	100	50	7.5	6.5	1270	310	310	60	130	STD 27MM	612	245	255	10	
Tau II 48	Remote	LED 3000k	18	900	Array	35	6750	198	100	50	7.5	6.5	1270	310	310	60	130	STD 27MM	612	245	255	10	
Titan Linear 84	Remote	LED 6000k	18	1500	Array	45	13367	113	79	54	7.2/6.2	6.2/5.2	2083	n/a	210	n/a	145	STD 27MM	605/1027	295/426	315/558	2	
Titan Turbine 82	Remote	LED 6000k	18	1500	Array	45	13367	113	79	54	7.2/6.2	7.4/6.3	2134	n/a	210	n/a	145	STD 27MM	605/1005	295/120	315/125	2	
Viper Plus 44	Remote	LED 3000k	20	1010	Array	92	5262	271	203	116	11.4	10.1	1120	320	420	100	133	STD 27MM	300	660	260	10	
Viper Plus 54	Remote	LED 3000k	20	1010	Array	106	6612	199	140	80	11.4	10.1	1370	320	420	100	133	STD 27MM	300	660	260	10	
Zeta	Remote	LED 2800k	18	550	ARRAY	32	5387	173	125	50	6.8	5.7	1320	240	300	50	180	N/A	690	340	230	15	



Fantasia

Ceiling Fans

Fantasia Distribution Ltd

Unit B, The Flyers Way, Westerham, Kent TN16 1DE, United Kingdom

t: +44 (0)1959 564440

e: info@fantasiaceilingfans.com

 [@FansByFantasia](https://twitter.com/FansByFantasia)

 facebook.com/FantasiaUK

www.fantasiaceilingfans.com