



2025/26 Collection



Cool Breeze

Warm Air Re-Circulation

Low Running Costs

Contemporary Style



High quality ceiling fans to help you relax, sleep well, cool down, warm up, feel good, beat jet lag, impress your friends, save energy and improve your life!



What makes Fantasia the right ceiling fan option for you!

Not all ceiling fans are created equal. Yes, we know. The ceiling fan in the Spanish Hotel room in 1987 was terrible, noisy and wobbly and you didn't dare use it. Fantasia fans are not like that. We offer high quality, well balanced motors, designed to run quietly and in a civilised manner.

Control options run from pull cord to remote control, and installations can use drop rods up to 72" 183cm in length for those higher ceilings. Quality and flexibility are key parts of everything we design.

How you will benefit from a ceiling fan?

A ceiling fan will change your life for the better. That's right, you read that correctly. People who have ceiling fans always tell us they couldn't do without one (or 6). People who've bought one often buy another and another.

The feedback from customers is very often "I don't know how I managed without a ceiling fan. Ceiling fans can be the difference between a good night's sleep and a bad night's sleep, they can make a room usable rather than far too hot, they can also even out the temperature in a room so that your radiators or heat pump (!) actually work efficiently and your thermostat actually knows what temperature the room is.

What are these things worth to you?

The Questions we are asked most regularly:

Are Ceiling Fans Noisy?

Everyone has had an experience of a noisy ceiling fan. At Fantasia, our motors are designed to be as quiet as possible and certainly at the higher end of the range we would expect you to be able to sleep under a fan spinning on medium speed all night.

Can I operate the fan and light independently?

A surprisingly common question, the answer is yes. Complete independent control of fan and light is no problem on any Fantasia ceiling fan

The power consumption question - AC/DC, which is best?

Lets face it, Moneytalks, and it Ain't No Fun spending too much on your energy bill, the last place you want to be is on the Highway to Hell. So is AC or DC the better motor option?

Well all Fantasia ceiling fan motors can be considered low energy as they are all below 100w when operated on high speed. DC motors do run with lower power consumption (usually 30-40w) but the main benefit comes with more features that DC motors bring. More speeds (6 rather than 3), and also pulse functions (speed up, slow down, speed up, slow down etc) mean that DC motors are a better choice for some.

Do I need special wiring for a ceiling fan?

No, all Fantasia ceiling fans are designed to run on the 5amp lighting circuit. An earth wire connection is required.

How does the fan attach to the ceiling?

A fixing bracket or plate is included with the fan. It is essential that the ceiling fan is mounted securely to a ceiling joist (not just plasterboard) or conservatory ridge plate.

So you know you want a ceiling fan, but which one?

What Size?

Unless space is an issue then we recommend a 36" fan be the absolute minimum size you should fit in a room. We do make smaller ones but they are really for areas that cannot fit a larger fan. For a standard bedroom a single 42"-52" fan situated above the bed will work well, for a large rectangular lounge you may want to fit 2 x 42" fans or 1 x 52"-56" fan

What colour/finish?

If you want the fan to blend into the ceiling then go for a White finish. After a week or so you'll hardly notice it. If you want the fan to be a feature in the room then Brushed Nickel is lovely. You'll also find other finishes to suit your own décor.

What's your budget?

How much you want to spend will dictate whether you go for a DC motor rather than an AC motor, or if you have remote control operation rather than pull cord. Very generally larger ceiling fans cost a little more too.

Contents

Elite Range

Sirocco
Zeta
Luna
Stellar
Viper Plus
Blade
Titan

Fantasia Range

Fairbanks
Palm
Darwin
Classic
Mayfair
Capri
Kompact

Eurofans Range

Neptune
Belaire
Montana/Moreno
Atlanta
Commercial Fans

Contact us

We're a small family business and we want to help as much as possible but calling us on the phone (particularly in Summer) will not be the quickest way of getting answers to your questions. The best options are:

1. Check the website knowledge base. Your questions will have been asked before and the answer is there. www.fantasiaceilingfans.com.
2. Live chat. Also on our website, we can respond quickly there.
3. Whatsapp. Message us on 07599 095556 and again you will get an answer quickly.

117414

White 54"/137cm
Blades: White



Fun Fact: In high speed the Sirocco fan motor consumes just 35w of energy

Remote Control Included

DC MOTOR

Extra Efficiency

MAX POWER CONSUMPTION

55w

ON HIGH SPEED WITH LIGHT SWITCHED ON

MAX AIRFLOW
7100 CU/FT PER MINUTE

KEY FEATURES AND BENEFITS

- Lovely sleek design
- Complete with remote control system offering 6 speeds in forward & reverse and light on/off/dim, and 1hr, 3hr, 4hr timer
- 20w Dimmable LED light
- Elegant curved blade style
- Reversible - Use in Summer for Cooling and in Winter to re-circulate warm air
- Longer drop rods available

Ideal for Bedrooms, Living Rooms, Orangeries and Conservatories

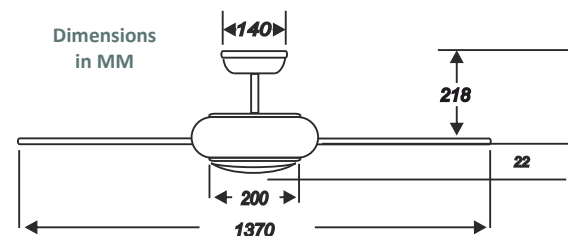

INSTALLATION

- ★ Always fix to a ceiling joist
- ★ 2 core + Earth wiring required
- ★ Isolation switch recommended
- ★ Ensure minimum clearance of 8"/20cm all around blades for effective airflow

114963

White
52"/1320mm
Blades: White
LED Light

114970

Brushed Nickel
52"/1320mm
Blades: Walnut
LED Light

115090

Brushed Nickel
52"/1320mm
Blades: Silver
LED Light



Fun Fact: Zeta blades are hand carved from sustainable Paulownia wood



Remote Control Included



DC MOTOR

Extra Efficiency

MAX POWER CONSUMPTION

50w

ON HIGH SPEED WITH LIGHT SWITCHED ON

MAX AIRFLOW

5387 CU/FT PER MINUTE

KEY FEATURES AND BENEFITS

- Low energy DC motor
- Complete with remote control system offering 6 speeds in forward & reverse and light on/off/dim
- 18w LED light
- Elegant curved blade style
- Reversible - Use in Summer for Cooling and in Winter to re-circulate warm air
- Flush mount only

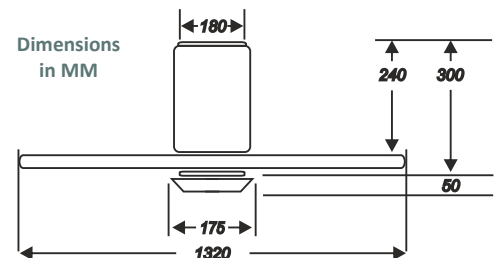

INSTALLATION

- ★ Always fix to a ceiling joist
- ★ 2 core + Earth wiring required
- ★ Isolation switch recommended
- ★ Ensure minimum clearance of 8"/20cm all around blades for effective airflow

Ideal for Bedrooms, Living Rooms, Orangeries and Conservatories

Contemporary design, feature packed, low energy

Silver
117780 46"/117cm
117766 40"/102cm
Blades: Silver

White
117797 52"/132cm
117773 46"/117cm
117759 40"/102cm
Blades: White



Luna can be fitted with 3, 4 or 5 blades.



Fun Fact: When operated on low speed the Luna ceiling fan motor consumes just 4 watts

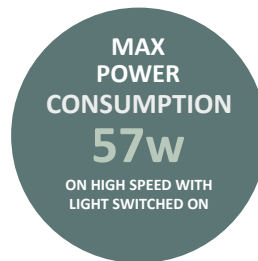

KEY FEATURES AND BENEFITS

- Lovely sleek design
- Complete with remote control system offering 6 speeds in forward & reverse and light on/off/dim, and 1hr, 2hr, 4hr timer
- 22w Dimmable LED light
- LED Light with colour changing technology. Can be set at colour temperatures 3000k, 4000k or 6000
- Reversible - Use in Summer for Cooling and in Winter to re-circulate warm air
- Longer drop rods available

Ideal for Bedrooms, Living Rooms, Orangeries and Conservatories

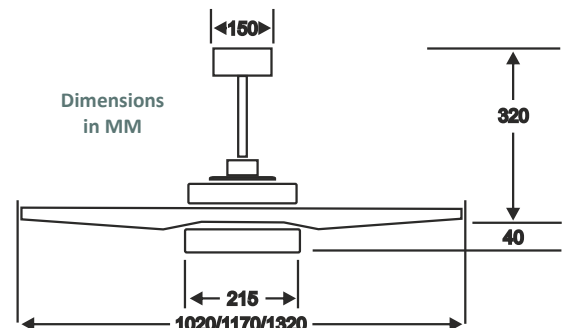

INSTALLATION

- ★ Always fix to a ceiling joist
- ★ 2 core + Earth wiring required
- ★ Isolation switch recommended
- ★ Ensure minimum clearance of 8"/20cm all around blades for effective airflow

Contemporary design, feature packed, low energy

117735

Silver 40"/102cm
Blades: Silver



Fun Fact: Stellar is new for 2025

Remote Control Included

117728

Matt White 40"/102cm
Blades: Matt White



Stellar comes with a blanking plate for the light if preferred

DC MOTOR

Extra Efficiency

MAX POWER CONSUMPTION

52w

ON HIGH SPEED WITH LIGHT SWITCHED ON

MAX AIRFLOW
6400 CU/FT PER MINUTE

KEY FEATURES AND BENEFITS

- Our newest addition to the range
- Complete with remote control system offering 6 speeds in forward & reverse and light on/off/dim, and 1hr, 2hr, 4hr timer
- 22w Dimmable LED light, Lumens 1880/2198/1964
- LED Light with colour changing technology. Can be set at colour temperatures 3000k, 4500k or 6000
- Reversible - Use in Summer for Cooling and in Winter to re-circulate warm air
- Longer drop rods available

Ideal for Bedrooms, Living Rooms, Orangeries and Conservatories

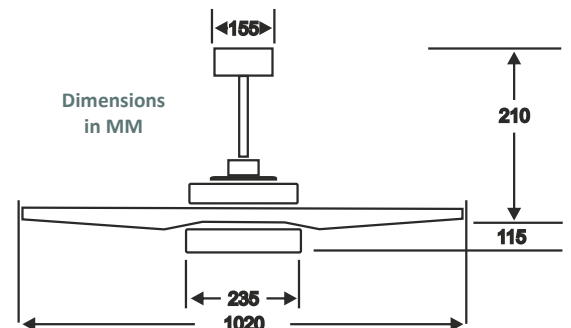

INSTALLATION

- ★ Always fix to a ceiling joist
- ★ 2 core + Earth wiring required
- ★ Isolation switch recommended
- ★ Ensure minimum clearance of 8"/20cm all around blades for effective airflow

Viper Plus

The original and still one of the best

116110

Pewter 54"/137cm
116059
Pewter 44"/112cm
Blades: Gloss Black

116066

White 54"/137cm
116004
White 44"/112cm
Blades: Gloss White

116080

Stainless Steel 54"/137cm
116028
Stainless Steel 44"/112cm
Blades: Maple



Note: The Viper Plus Stainless Steel is shown fitted with a flush mount kit. Its available on the product codes below

333432 Flush Mount Kit - White
333456 Flush Mount Kit - St Steel
333470 Flush Mount Kit - Pewter



Fun Fact: The original Viper was designed in 1990

Remote Control Included



*This Viper Plus is shown fitted with a flush mount kit, available separately

AC MOTOR
Extra Efficiency

MAX POWER CONSUMPTION
126w
ON HIGH SPEED WITH LIGHT SWITCHED ON

MAX AIRFLOW
6600 CU/FT PER MINUTE

KEY FEATURES AND BENEFITS

- One of the best loved ceiling fans in the range
- Complete with remote control system offering 3 speeds in forward & reverse and light on/off/dim
- 22w Dimmable LED light
- Supplied as standard with a 6"/15cm drop rod, can be flush mounted with the use of an additional kit.
- Reversible - Use in Summer for Cooling and in Winter to re-circulate warm air
- Longer drop rods available

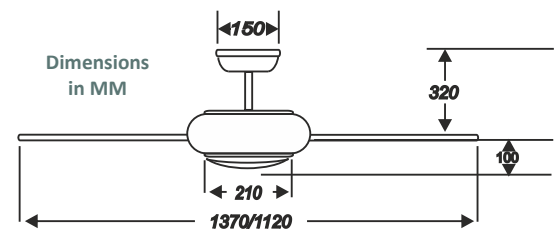

INSTALLATION

- ★ Always fix to a ceiling joist
- ★ 2 core + Earth wiring required
- ★ Isolation switch recommended
- ★ Ensure minimum clearance of 8"/20cm all around blades for effective airflow

Ideal for Bedrooms, Living Rooms, Orangeries and Conservatories

115007

Brushed Aluminium
42" / 107cm
Blades: Silver

115014

White 42" / 107cm
Blades: White

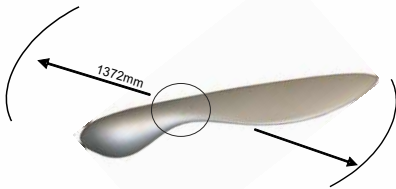

Blade has an overall spinning diameter of 1372mm

! Fun Fact: Blade was designed in Australia

Remote Control Included

AC MOTOR

MAX POWER CONSUMPTION
60w
ON HIGH SPEED

MAX AIRFLOW
4100 CU/FT PER MINUTE

KEY FEATURES AND BENEFITS

- Unique design
- Complete with remote control system offering 3 speeds in forward. No reverse option.
- Spinning Diameter 1372mm
- Patented single blade design
- International design award winner
- Longer drop rods available

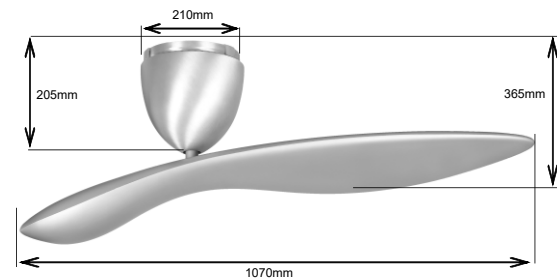

INSTALLATION

- ★ Always fix to a ceiling joist
- ★ 2 core + Earth wiring required
- ★ Isolation switch recommended
- ★ Ensure minimum clearance of 8"/20cm all around blades for effective airflow

Ideal for Bedrooms, Living Rooms, Orangeries and Conservatories

Titan Turbine

117582

Brushed Titanium
82"/209cm overall span
LED Light

117575

Brushed Titanium
82"/209cm overall span

Titan Linear

117605

Brushed Titanium
84"/214cm overall span
LED Light

117599

Brushed Titanium
84"/214cm overall span

Titan is shown here without a light



! Fun Fact: Titan is the most efficient ceiling fan we offer with a huge 297cu/ft per min per watt!

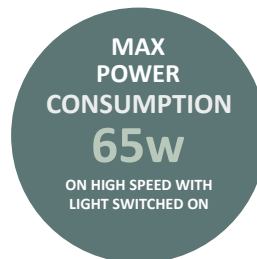

KEY FEATURES AND BENEFITS

- Lots of air movement, Ideal for very large rooms with high ceilings
- Complete with remote control system offering 3 speeds in forward & reverse and light on/off/dim, and 1hr, 4hr, 8hr switch off timer
- 18w 6000k Dimmable LED light. Titan can be ordered with or without a light
- Reverse function on remote - Use in Summer for Cooling and in Winter to re-circulate warm air
- 12" Drop Rod included

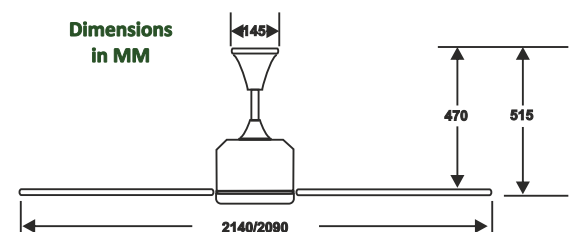

INSTALLATION

- ★ Always fix to a ceiling joist
- ★ 2 core + Earth wiring required
- ★ Isolation switch recommended
- ★ Ensure minimum clearance of 8"/20cm all around blades for effective airflow

Ideal for really large spaces with very high ceilings

117520

White 42"/107cm
Blades: Matt White
Cool White LED Light

117537

White 42"/107cm
Blades: Matt White
Warm White LED Light

117551

Brushed Nickel 42"/107cm
Blades: Silver
Cool White LED Light

117568

Brushed Nickel 42"/107cm
Blades: Silver
Warm White LED Light



Fairbanks can be flush mounted if preferred

! Fun Fact: This fan can be flush mounted OR drop mounted depending on ceiling height

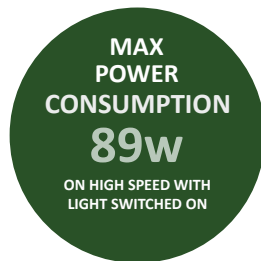

KEY FEATURES AND BENEFITS

- Quality at a great price
- Complete with remote control system offering 3 speeds in forward & reverse and light on/off/dim, and 2hr, 4hr, 8hr switch off timer
- 9w Dimmable LED light
- LED Light Choice of warm or cool white light bulbs. Specify when ordering
- Reverse Switch on Motor - Use in Summer for Cooling and in Winter to re-circulate warm air
- Longer drop rods available

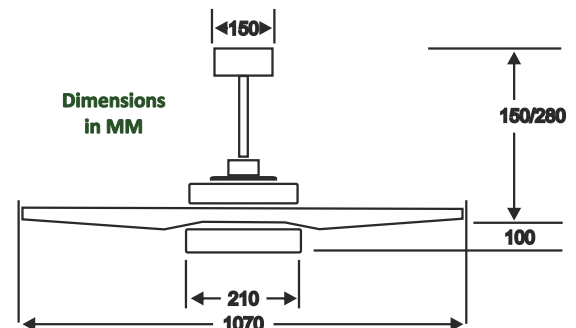

INSTALLATION

- ★ Always fix to a ceiling joist
- ★ 2 core + Earth wiring required
- ★ Isolation switch recommended
- ★ Ensure minimum clearance of 8"/20cm all around blades for effective airflow

Ideal for Bedrooms, Living Rooms, Orangeries and Conservatories

Unique ceiling fan rated for covered outdoor use

114871

Chocolate Brown
52"/1320mm
Blades: Natural Brown Acrylic
Light: Patio 2 x 60w max ES

111665

Chocolate Brown
52"/1320mm
Blades: Natural Brown Acrylic



For a different light option add the Amorie CB to the Palm fan - 221500
Note this light fitting is not IP rated

! Fun Fact: The Palm Fan can be used outdoors under covered gazebos for example!



IP RATED
AC MOTOR
Extra Efficiency

MAX POWER CONSUMPTION
50w
ON HIGH SPEED WITH LIGHT SWITCHED ON

MAX AIRFLOW
5373 CU/FT PER MINUTE

KEY FEATURES AND BENEFITS

- IP54 rated, perfect for indoor or covered outdoor use
- Can be upgraded to remote control (not for outdoor use)
- Independent pull cord operates 3 speeds in forward & reverse and light on/off
- Reverse Switch on Motor - Use in Summer for Cooling and in Winter to re-circulate warm air
- Longer drop rods available

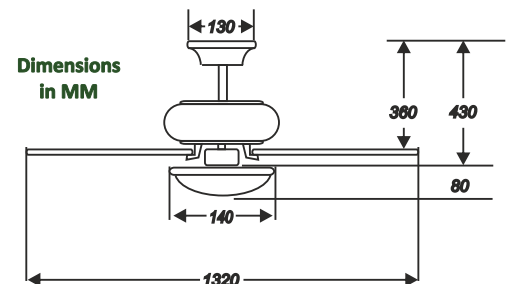

INSTALLATION

- ★ Always fix to a ceiling joist
- ★ 2 core + Earth wiring required
- ★ Isolation switch recommended
- ★ Ensure minimum clearance of 8"/20cm all around blades for effective airflow

Ideal for covered outdoor spaces or large living rooms

Brushed Nickel
117353 52"/1320mm (shown)
117360 44"/1120mm
117698 36"/914mm
Blades: Vintage Oak

Matt White
117377 52"/1320mm (shown)
117384 44"/1120mm
117681 36"/914mm
Blades: Matt White



Darwin can be flush mounted if preferred



Fun Fact: The Darwin fan is available in 3 different diameters - 36" 44" or 52"

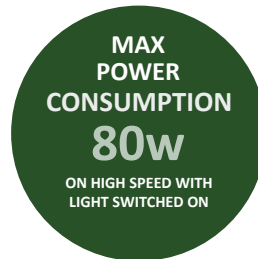
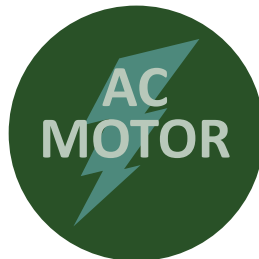

KEY FEATURES AND BENEFITS

- Complete with remote control system offering 3 speeds in forward & reverse and light on/off/dim. Timer 2/4/6hr
- 15w LED Light
- Sleek 3 bladed design
- Available in 3 sizes
- Reverse Switch on Motor - Use in Summer for Cooling and in Winter to re-circulate warm air
- Longer drop rods available

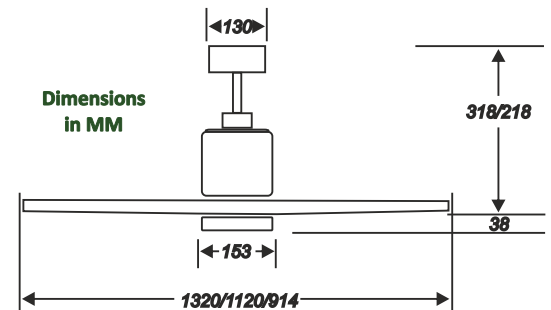

INSTALLATION

- ★ Always fix to a ceiling joist
- ★ 2 core + Earth wiring required
- ★ Isolation switch recommended
- ★ Ensure minimum clearance of 8"/20cm all around blades for effective airflow

Ideal for conservatories, orangeries, living rooms & bedrooms

Traditional style that works in contemporary rooms

1 110224

Antique Brass 52"/1320mm
Blades: Matt Oak & Cane
Blades reverse: Matt Mahogany



2 110033

Gloss White 52"/1320mm
Blades: Matt White
Blades reverse: Matt White & Cane



3 110019

Polished Brass 52"/1320mm
Blades: Matt Mahogany
Blades reverse: Matt Oak & Cane



KEY FEATURES AND BENEFITS

- Can be upgraded to remote control operation
- Independent pull cord operates 3 speeds in forward & reverse and light on/off (if a light is added)
- Dual Mount Fixing means fan can be fitted with or without drop rod
- Available in 5 finishes
- Reverse Switch on Motor - Use in Summer for Cooling and in Winter to re-circulate warm air
- Longer drop rods available

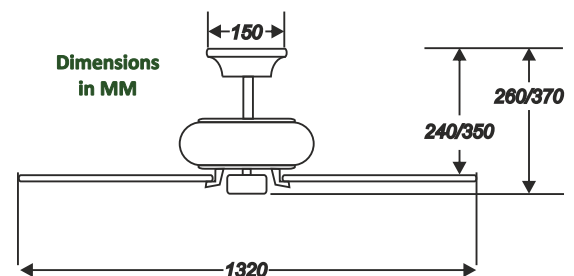

INSTALLATION

- ★ Always fix to a ceiling joist
- ★ 2 core + Earth wiring required
- ★ Isolation switch recommended
- ★ Ensure minimum clearance of 8"/20cm all around blades for effective airflow

Ideal for conservatories, orangeries, living rooms & bedrooms

Traditional style that works in contemporary rooms

! **Fun Fact:** Classic is dual-mount. It can be mounted flush or drop straight out of the box!

4 **117827**

Brushed Nickel 52"/1320mm
Blades: Maple



5 **110460**

Gloss Black 52"/1320mm
Blades: Matt Black
Blades reverse: Matt Mahogany

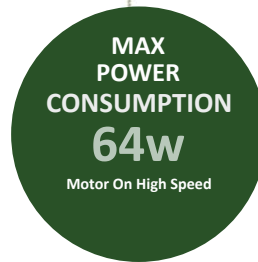
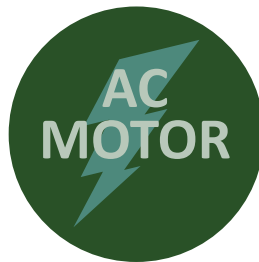

Dual Mount Ceiling Fans

The Classic fan is an example of a dual mount fan. This means it can be mounted flush or on a drop rod straight out of the box. No additional parts required. Other dual mount fans include Fairbanks, Darwin, Neptune, Belaire, Montana & Moreno



Classic ceiling fan shown flush mounted



Classic ceiling fan shown mounted with its included 6"/15cm drop rod

in the Mayfair range you will find a finish to suit any decor

1 111825

Gloss White 42"/107cm
Light: Amorie 3 x G9
Blades: Gloss White

2 110009

White & Stainless Steel 42"/107cm
Light: Amorie 3 x G9
Blades: Gloss White

3 110644

Gloss White 42"/107cm
Blades: Gloss White

4 110606

White & Stainless Steel 42"/107cm
Blades: Gloss White

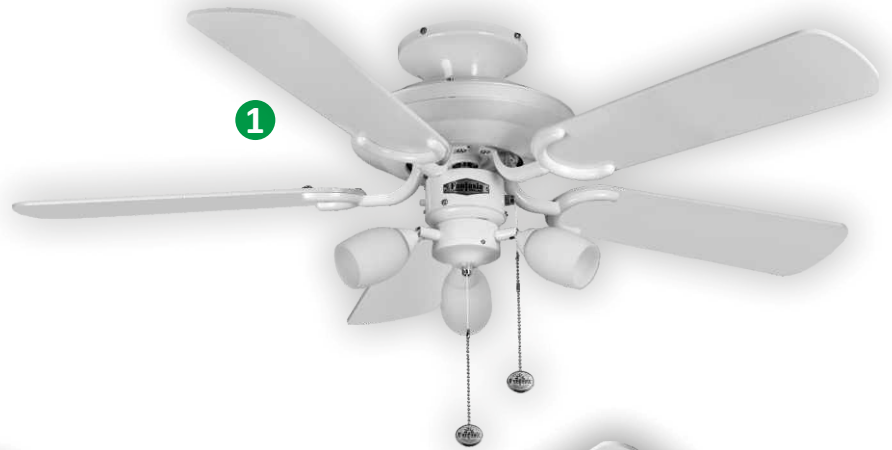

KEY FEATURES AND BENEFITS

- Can be upgraded to remote control operation
- Independent pull cord operates 3 speeds in forward & reverse and light on/off
- Optional upgrade to LED bulbs
- Available in 7 finishes
- Reverse Switch on Motor - Use in Summer for Cooling and in Winter to re-circulate warm air
- Can be fitted with a drop rod rather than flush mounted, conversion kit required

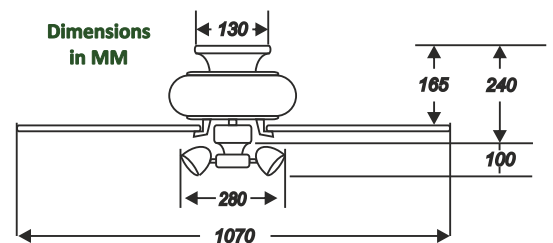

INSTALLATION

- ★ Always fix to a ceiling joist
- ★ 2 core + Earth wiring required
- ★ Isolation switch recommended
- ★ Ensure minimum clearance of 8"/20cm all around blades for effective airflow

Ideal for kitchens, living rooms & bedrooms

in the Mayfair range you will find a finish to suit any decor

1 110996

Matt Black 42"/107cm
Light: Amorie 3 x G9
Blades: Matt Black

2 111962

Antique Brass 42"/107cm
Light: Amorie 3 x G9
Blades: Gloss Oak & Cane
Blade Reverse: Mahogany

3 110507

Matt Black 42"/107cm
Blades: Matt Black

4 110057

Antique Brass 42"/107cm
Blades: Gloss Oak & Cane
Blade Reverse: Mahogany



KEY FEATURES AND BENEFITS

- Can be upgraded to remote control operation
- Independent pull cord operates 3 speeds in forward & reverse and light on/off
- Optional upgrade to LED bulbs
- Available in 7 finishes
- Reverse Switch on Motor - Use in Summer for Cooling and in Winter to re-circulate warm air
- Can be fitted with a drop rod rather than flush mounted, conversion kit required

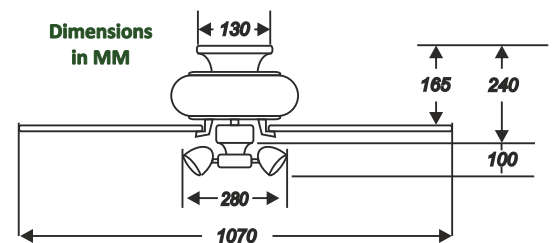

INSTALLATION

- ★ Always fix to a ceiling joist
- ★ 2 core + Earth wiring required
- ★ Isolation switch recommended
- ★ Ensure minimum clearance of 8"/20cm all around blades for effective airflow

Ideal for kitchens, living rooms & bedrooms

in the Mayfair range you will find a finish to suit any decor

1 115496

Stainless Steel 42"/107cm
Light: Amorie 3 x G9
Blades: Dark Oak



2 115441

Stainless Steel 42"/107cm
Blades: Dark Oak

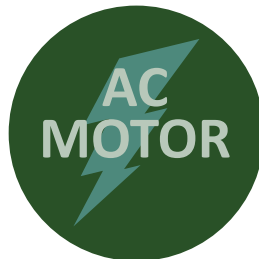

KEY FEATURES AND BENEFITS

- Can be upgraded to remote control operation
- Independent pull cord operates 3 speeds in forward & reverse and light on/off

Optional upgrade to LED bulbs

- Available in 7 finishes
- Reverse Switch on Motor - Use in Summer for Cooling and in Winter to re-circulate warm air
- Can be fitted with a drop rod rather than flush mounted, conversion kit required

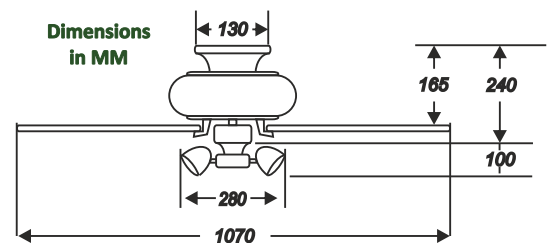

INSTALLATION

- ★ Always fix to a ceiling joist
- ★ 2 core + Earth wiring required
- ★ Isolation switch recommended
- ★ Ensure minimum clearance of 8"/20cm all around blades for effective airflow

Ideal for kitchens, living rooms & bedrooms

110538

Gloss White & Stainless Steel
36"/92cm
Light: 3x60w Max SES
Blades: Matt White

110194

Gloss White 36"/92cm
Light: 3x60w Max SES
Blades: Matt White

110187

Stainless Steel 36"/92cm
Light: 3x60w Max SES
Blades: Silver
Blade Reverse: Washed Oak

110521

Gloss White &
Stainless Steel 36"/92cm
Light: 3x60w Max SES
Blades: Matt White



110255

Stainless Steel 36"/92cm
Light: 3x60w Max SES
Blades: Washed Oak
Blade Reverse: Silver



110200

Gloss White 36"/92cm
Light: 3x60w Max SES
Blades: Matt White

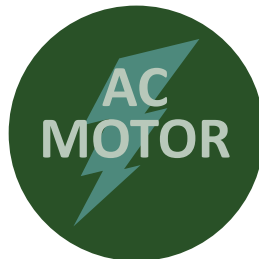
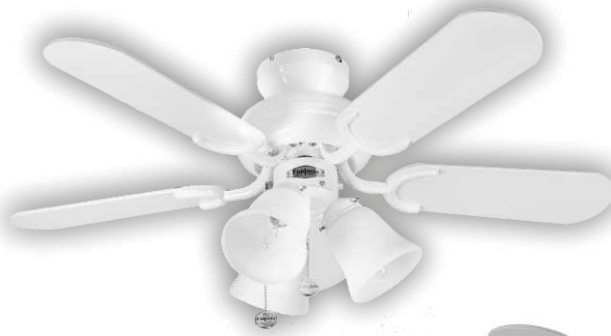

KEY FEATURES AND BENEFITS

- Can be upgraded to remote control operation
- Independent pull cord operates 3 speeds in forward & reverse and light on/off
- 3 x 60w (Max) SES. Bulbs not included
- Reverse Switch on Motor - Use in Summer for Cooling and in Winter to re-circulate warm air
- Can be fitted with a drop rod rather than flush mounted, conversion kit required

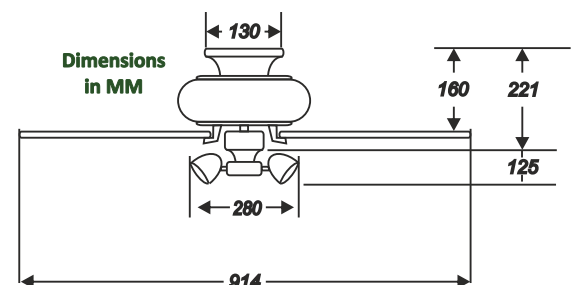

INSTALLATION

- ★ Always fix to a ceiling joist
- ★ 2 core + Earth wiring required
- ★ Isolation switch recommended
- ★ Ensure minimum clearance of 8"/20cm all around blades for effective airflow

Ideal for small bedrooms, hallways and space-restricted areas

115557

Brushed Nickel 28"/711mm

Blades: Maple

Blades Reverse: Dark Oak

Light: 18w LED 4000k



Note that the Kompact is a dual mount ceiling fan so it can be flush or drop mounted straight out of the box

! Fun Fact: the Kompact is the smallest diameter fan in our range at 28"/711mm



AC
MOTOR

MAX
POWER
CONSUMPTION
64w

ON HIGH SPEED WITH
LIGHT SWITCHED ON

MAX
AIRFLOW
**4280 CU/FT
PER MINUTE**

KEY FEATURES AND BENEFITS

- Can be upgraded to remote control operation
- Independent pull cord operates 3 speeds in forward & reverse and light on/off
- LED Light - 18w, 4000k, 1310 lumen
- Reverse Switch on Motor - Use in Summer for Cooling and in Winter to re-circulate warm air
- Longer drop rods available

Ideal for small bedrooms, hallways and space-restricted areas

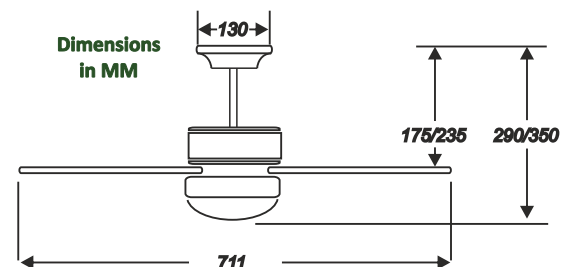

INSTALLATION

- ★ Always fix to a ceiling joist
- ★ 2 core + Earth wiring required
- ★ Isolation switch recommended
- ★ Ensure minimum clearance of 8"/20cm all around blades for effective airflow

115847

White 54"/1370mm
Blades: White

115861

White 44"/1120mm
Blades: White

115854

Brushed Nickel 54"/1370mm
Blades: Silver

115878

Brushed Nickel 44"/1120mm
Blades: Silver

The Neptune ceiling fan is a dual-mount fan so it can either be mounted with its drop rod OR flush mount (shown here) straight out of the box



Fun Fact: When mounted on a drop rod, Neptune (like all drop mounted fans) can accommodate a sloping ceiling up to 20 degrees

Remote Control Included

AC MOTOR

MAX POWER CONSUMPTION
105w
ON HIGH SPEED WITH LIGHT SWITCHED ON

MAX AIRFLOW
5300 CU/FT PER MINUTE

KEY FEATURES AND BENEFITS

- Timeless design
- Complete with remote control system offering 3 speeds in forward & reverse and light on/off/dim
- 20w 3000k 940 Lumen Dimmable LED light
- Available in 2 sizes, 54"/137cm or 44"/112cm overall diameter to suit most room sizes
- Reversible - Use in Summer for Cooling and in Winter to re-circulate warm air. Reverse switch on motor
- Longer drop rods available

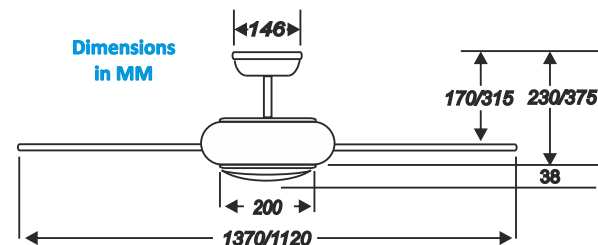

INSTALLATION

- ★ Always fix to a ceiling joist
- ★ 2 core + Earth wiring required
- ★ Isolation switch recommended
- ★ Ensure minimum clearance of 8"/20cm all around blades for effective airflow

Ideal for Bedrooms, Living Rooms, Orangeries and Conservatories

1 110477

White 42"/1070mm
Blades: Matt White
Blade Reverse:
Matt White & Cane
Light: 3 x 60w (max) SES
The same model is shown in
Fig. 2 with its (inc) 12"/30cm
drop rod attached

3 114239

Brushed Nickel 42"/1070mm
Blades: Maple
Blade reverse: Dark Oak
Light: 3x60w (max) SES

4 114192

Polished Brass 42"/1070mm
Blades: Matt Oak & Cane
Blade reverse: Mahogany
Light: 3x60w (max) SE

5 110095

White 42"/1070mm
Blades: Matt White & Cane
Blades reverse: White



! Fun Fact: The Belaire fan comes with a 6"/15cm and also a 12"/30cm drop rod in the box as standard

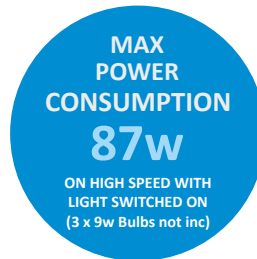

KEY FEATURES AND BENEFITS

- Dual Mount - Can be flush or drop mounted straight out of the box
- Pull cord operation as standard, 3 speeds and light on/off
- 3 x 60w (max) E14 SES Light - Bulbs not included
- You can add a remote control system offering 3 speeds in forward & reverse and light on/off/dim (See P26)
- Reversible - Use in Summer for Cooling and in Winter to re-circulate warm air. Reverse switch on motor
- Longer Drop rods available

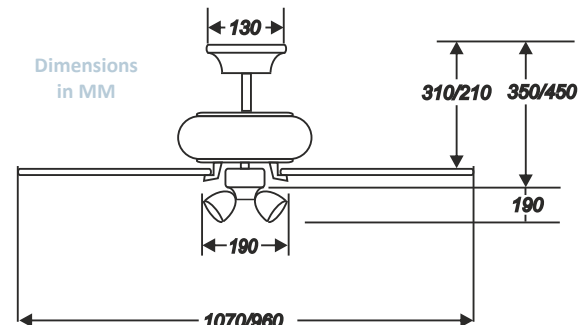

INSTALLATION

- ★ Always fix to a ceiling joist
- ★ 2 core + Earth wiring required
- ★ Isolation switch recommended
- ★ Ensure minimum clearance of 8"/20cm all around blades for effective airflow

Please note that the Belaire ceiling fan will accept an SES LED light bulb when used with pull cords. **IF** a remote control is to be used then please check compatibility with the dimming function of the light bulbs. With some brands flicker can occur

MONTANA

117483

White 42"/1070mm

117490

White 36"/920mm

Light: 3x60w (max) SES

Blades: White

MORENO

117452

White 42"/1070mm

117469

White 36"/920mm

Light: 1x60w (max) SES

Blades: White

Please note that the Montana & Moreno will accept an SES LED light bulb when used with pull cords. IF a remote control is to be used then please check compatibility with the dimming function of the light bulbs. With some brands flicker can occur



! Fun Fact: The ideal entry level ceiling fan for smaller rooms.

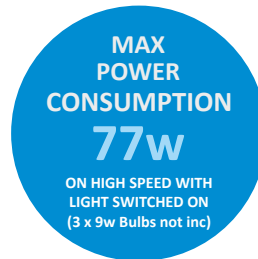

KEY FEATURES AND BENEFITS

- Dual Mount - Can be flush or drop mounted straight out of the box
- Pull cord operation as standard, 3 speeds and light on/off
- 3 x60w (max) E14 SES Light - Bulbs not included
- You can add a remote control system offering 3 speeds in forward & reverse and light on/off/dim. Note that a remote control can only be added if the fan is to be installed drop mounted.
- Reversible - Use in Summer for Cooling and in Winter to re-circulate warm air. Reverse switch on motor
- Longer Drop rods available

Ideal for Smaller Bedrooms, Hallways, Particularly lower ceilings

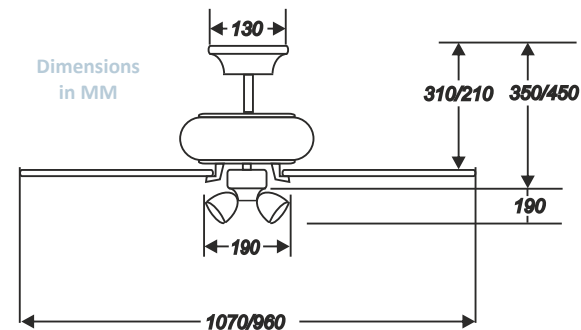

INSTALLATION

- ★ Always fix to a ceiling joist
- ★ 2 core + Earth wiring required
- ★ Isolation switch recommended
- ★ Ensure minimum clearance of 8"/20cm all around blades for effective airflow

111573

White 30"/762mm
Light: 1x60w SES Golf Ball
Blades: White



! Fun Fact: When flush mounted the Atlanta is one of the 'flushest' fans we offer. Ideal for lower ceilings.

114390

Brushed Nickel 30"/762mm
Light: 1x60w SES Golf Ball
Blades: White



The Atlanta ceiling fan is a dual-mount fan so it can either be mounted with its drop rod OR flush mount straight out of the box

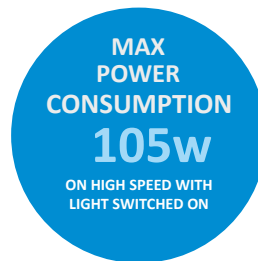

KEY FEATURES AND BENEFITS

- Compact and close coupled
- Pull cord operation as standard, 3 speeds and light on/off
- 60w Light - Bulb not included
- You can add a remote control system offering 3 speeds in forward & reverse and light on/off/dim
- Reversible - Use in Summer for Cooling and in Winter to re-circulate warm air. Reverse switch on motor
- Longer Drop rods available

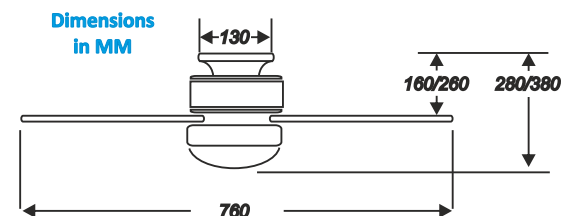

INSTALLATION

- ★ Always fix to a ceiling joist
- ★ 2 core + Earth wiring required
- ★ Isolation switch recommended
- ★ Ensure minimum clearance of 8"/20cm all around blades for effective airflow

Ideal for Smaller Bedrooms, Hallways, Particularly lower ceilings

Great for warehouses and offices with high ceilings

111870

White 36"/920mm
Blades: White
12"/30cm drop rod included

111887

White 48"/1220mm
Blades: White
12"/30cm & 24"/60cm drop rods included

111894

White 56"/1420mm
Blades: White
12"/30cm & 24"/60cm drop rods included



Fun Fact: When spinning on high speed, the blade tip of a 56"/142cm Commercial Fan travels at almost 50mph!



331674 RV-05

Controls up to 5 x fans
forward and reverse
Max 400w



333036 RV-01

Controls 1 x fan
forward and reverse
Max 100w



333029 SIC-1

Controls 1 x fan
forward only
Max 100w



KEY INFORMATION

- Minimum 10ft/3m floor to blade clearance required for metal bladed fans
- Efficient air movement
- Use in Summer for cooling and in Winter to re-circulate warm air.
- Note that a wall control is required for reverse function to operate

Dimensions
in MM

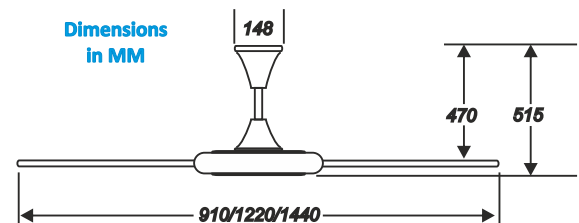

INSTALLATION

- ★ Always fix to a ceiling joist
- ★ 2 core + Earth wiring required
- ★ Isolation switch recommended
- ★ Ensure minimum clearance of 8"/20cm all around blades for effective airflow

Note that commercial fans are not recommended for domestic installations

331759 - M3 Remote Control System

RF remote system to suit to suit Mayfair, Capri, Classic & Belaire Fans. Note that this remote system is only compatible with ceiling fans that come with pull cords as standard. Other fans have specific remote control which are not compatible systems



Conversion Kit

Used to convert Mayfair and Capri fans from flush mount to drop mount. Note that the use of a conversion kit will also require a drop rod of the required length to be purchased



- 331049 - Stainless Steel
- 330257 - Gloss White
- 330035 - Chrome
- 330028 - Antique Brass
- 331063 - Matt Black

449003 - Fan Duster



Ideal for cleaning those hard-to-reach parts of your ceiling fan.

441199 - Big Strip Fastener

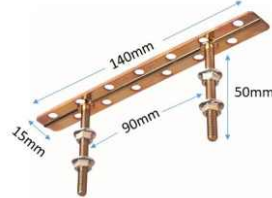

This is a fixing for use in conservatories where it can be hard to get a good fixing with just two screws.

Drop Rods

Used with a conversion kit to convert flush mount to drop mount fans OR used to replace the rod a drop mounted fan comes with. Note that drop rods come in two different diameters of 22 or 27mm OD. Please check compatibility before ordering. Also, Luna and Sirocco fans have their own specific drop rods.



At Fantasia we aim to make the best possible ceiling fans. However, we know they won't last forever, that's why we try to keep spare parts for Fantasia Ceiling Fans for at least 10 years from the date we discontinue a product. We should note that this isn't always possible but we have been fairly successful at it over the last 40 years.

1 Pull Cord Chain-1m 330547 - Pewter 330233 - Chrome 330226 - Pol. Brass	2 Dangler 440116 - Pewter 440123 - Chrome 440109 - Pol. Brass	3 Reverse Switch 441038 - White 441045 - Black 441069 - Wh (Viper) 441076 - Blk (Viper)	4 Light Pull Switch 440734 - Pewter 440727 - Chrome 440703 - Pol. Brass	5 Speed Pull Switch 440635 - Pewter 440628 - Chrome 440611 - Pol. Brass	6 Start Capacitor 440826 - Std Fans 440819 - Viper only 440772 - Commercial	7 Speed Capacitor 440802 - Mayfair/Capri
8 Amorie Shade Rings 441557 - Set of 3						

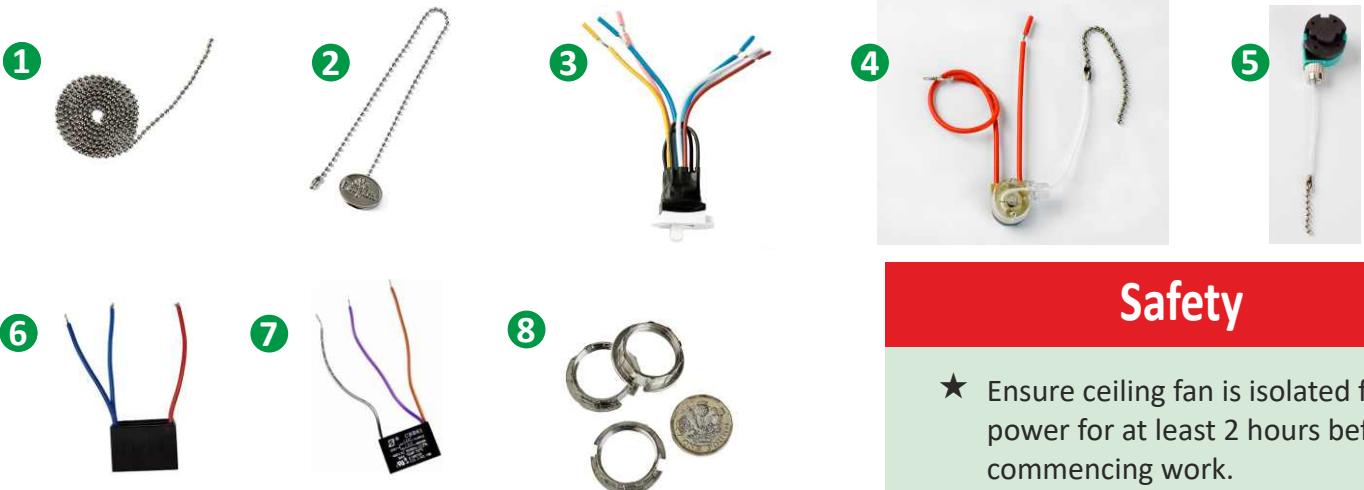

Safety

- ★ Ensure ceiling fan is isolated from power for at least 2 hours before commencing work.
- ★ Test for power isolation against a known source.
- ★ If in any doubt then consult a qualified Electrician

Flush Mount

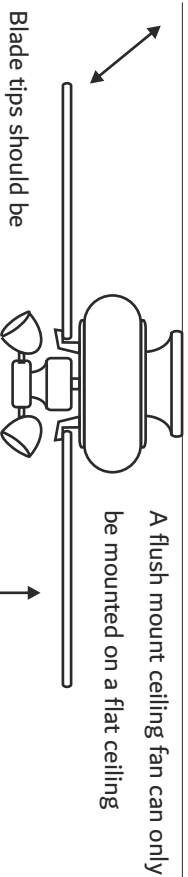

A flush mount ceiling fan can only be mounted on a flat ceiling

Blade tips should be at least 15cm from the nearest obstacle in any direction, eg tie bar, wall or roof beam

Ceiling fans blade should be at least 229cm from the floor

Drop Mount

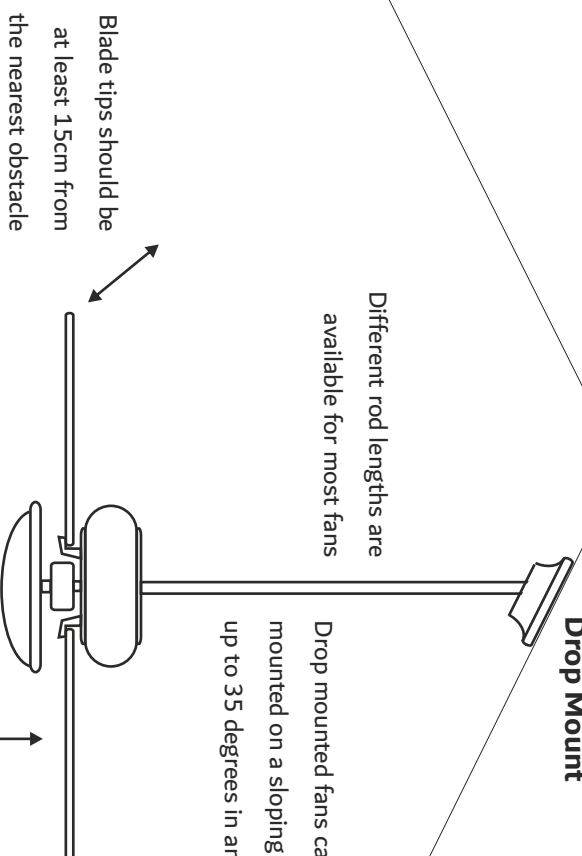

Different rod lengths are available for most fans

Drop mounted fans can be mounted on a sloping ceiling up to 35 degrees in angle

Blade tips should be at least 15cm from the nearest obstacle in any direction, eg tie bar, wall or roof beam

Ceiling fan blades should a minimum of 229cm and a maximum of 290cm above the floor to be safe and effective

To mount a ceiling fan in a conservatory a 'Big Strip Fastener' would be useful.
See page 45 of the Fantasia brochure



Fantasia Distribution Ltd
Britannia House
Faraday Way
Orpington
BR5 3QW
United Kingdom

01959 564440
www.fantasiaceilingfans.com
info@fantasiaceilingfans.com